



杭州中有触显智能科技
Hangzhou ZoYo Chuxian Intelligent Techonology



SKU.No.: DS10050

REV: A

PAGE: 1/28

NO: DSFN1400E001A

SPECIFICATION OF MODULE

MODULE NO: ZC-140001-0101
RoHS Complaint Product

Customer Approval:

Accept

Reject

ZOYO FOCUS	SIGNATURE	DATE
PREPARED BY	JYQ	2024.10.14
CHECKED BY	YG	2024.10.14
APPROVED BY		

Jimmy Jiang

Mobile:+86 13823181658

Email: jiangmg@zhongyou-tech.com

Company website: <https://displaysell.com/>

Hangzhou ZoYo Chuxian Intelligent Techonology Co.,Ltd.

Add: 6F,No.96, Fangxingdu Street, Linping District, Hangzhou,Zhejiang, China



杭州中有触显智能科技
Hangzhou ZoYo Chuxian Intelligent Techonology



SKU.No.: DS10050

REV: A

PAGE: 2/28

NO: DSFN1400E001A

Sample Version	Doc. Version	DATE	DESCRIPTION	CHECKED BY
01	A	2024.10.14	First Release.	YG



1. GENERAL DESCRIPTION:

ZC - 1400 01 - 0101

①

②

③

④

①

ZOYO Focus Brand

②

Display size: 14inch

③

LCM serial NO.

④

serial NO.

2. MECHANICAL SPECIFICATIONS:

ITEM	SPECIFICATION	Remark
Module Outline Dimension(W x H x D)(mm)	305.52(W)×195.44(H)×1.347(D)	
Active Area(mm)	301.824(H)×188.640(V)	
Pixel Pitch (um)	157.2x157.2	
Resolution(dot)	1920(H)×1200(V)	-
Driver IC(Type)	HX8874	-
Touch IC	HX8191	
Display Mode	AMOLED	-
Interface	eDP	
Color Depth	16.7M	-
Luminance	400 (TYP.)	cd/m ²
Viewing Direction	ALL	-

*See attached drawing for details.



3.BLOCK DIAGRAM:

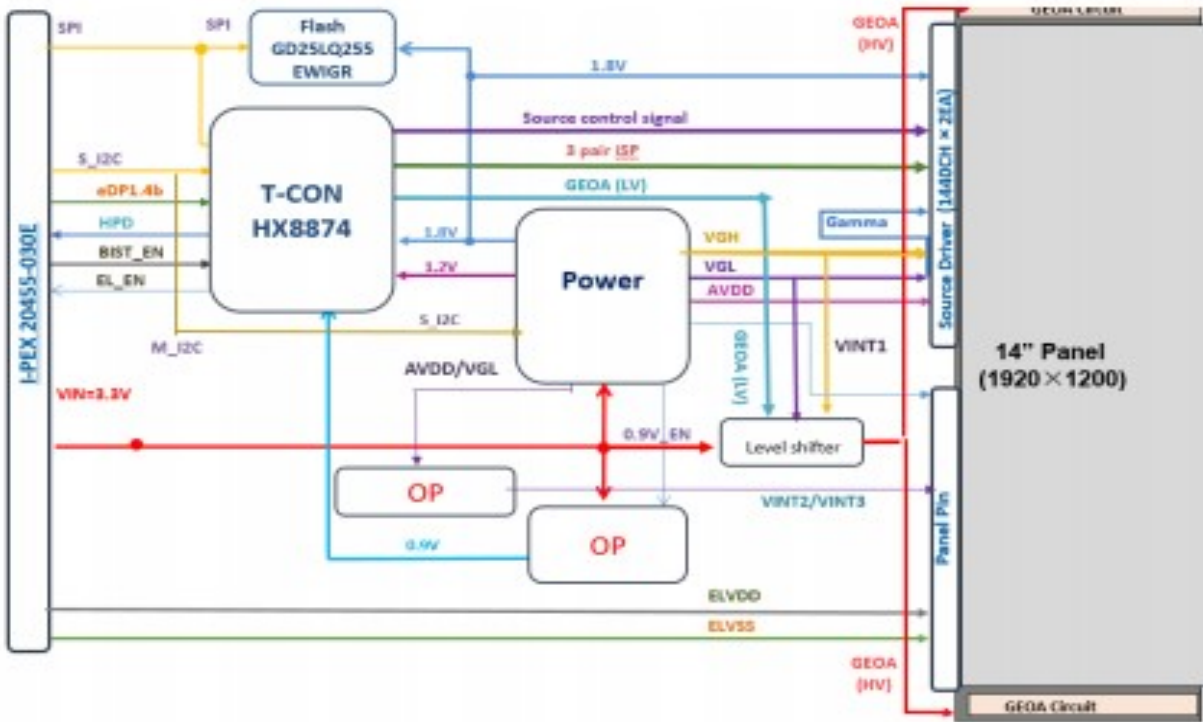



5. MAIN FPC PIN DESCRIPTION:

Pin No .	Symbol	I/O	Description	Note
1	GND	P	eDP signal ground.	
2	GND	P	eDP signal ground.	
3	DP_1N	I	eDP negative signal Lane1.	
4	DP_1P	I	eDP positive signal Lane1.	
5	GND	P	eDP signal ground.	
6	DP_0N	I	eDP negative signal Lane0.	
7	DP_0P	I	eDP positive signal Lane0.	
8	GND	P	eDP signal ground.	
9	AUX_P	I	eDP AUX positive signal.	
10	AUX_N	I	eDP AUX negative signal	
11	GND	P	eDP signal ground.	
12	NC	-	Do not used. Test pin for display.	
13	NC	-	Do not used. Test pin for display.	
14	BIST_EN_1.8V	P	BIST enable signal.	
15	VDD_3.3V	P	Logic and driver power.	
16	VDD_3.3V	P	Logic and driver power.	
17	HPD_2.6V	P	HPD signal.	
18	ELVSS	P	Panel Power.	
19	ELVSS	P	Panel Power.	
20	BLEN_1.8V	P	BL enable signal.	
21	ELVDD	P	Panel Power.	
22	ELVDD	P	Panel Power.	
23	EL_ON2	P	Enable for EL PMIC(1.8V).	
24	NC	-	Do not used. Test pin for display.	
25	NC	-	Do not used. Test pin for display.	
26	NC	-	Do not used. Test pin for display.	
27	NC	-	Do not used. Test pin for display.	
28	NC	-	Do not used. Test pin for display.	
29	NC	-	Do not used. Test pin for display.	
30	NC	-	Do not used. Test pin for display.	

Connector Name/Designation	Interface Connector/Interface Card
Type Part Number	20455-030E-02M(IPEX)
Mating Housing Part Number	20453-030T-01(IPEX)

Note: I=Input; O=Output; P=Power; I/O=Input / Output



6. ELECTRICAL CHARACTERISTICS

6.1 Absolute Maximum Ratings

Parameter		Symbol	Min.	Typ..	Max.	Unit	Remarks
Supply Voltage	System	VDD_3.3V	-0.3	-	4.6	V	
	EL Power	ELVDD	-0.3	4.6	6.0	V	
		ELVSS	-9	-3.5	0.3	V	
Operating temperature		Topr	-10		60	°C	
Storage temperature		Tstg	-30		70	°C	

6.2 Electrical Characteristics

Item		Symbol		Min.	Typ.	Max.	Uni	Noet
System	Analog/Logic Vol.	VDD_3.3V		3.0	3.3	3.6	V	
Panel	Analog Vol.	ELVDD		-	4.6	-	V	
		ELVSS		-	-3.5	-	V	
Current	Logic	VDD_3.3V	Full white VDD_3.3V =3.3V	-	TBD	410	mA	(1)
	Panel	ELVDD/ELVSS		-	847.7	932.5		
Consumption	Logic (60Hz)	VDD_3.3V	ELVDD/ELVSS=4.6/-3.5V	-	TBD	1.35	W	
	Panel	ELVDD/ELVSS		-	6.86	7.55		
Frame Frequency		fps		-	60	-	Hz	

Note (1): VDD_3.3V=3.3 (V) ELVDD/ELVSS =4.6/-3.5 (V), Full White pattern, Temperature = 22 ± 3°C Room Temperature



7. Recommended Operating Sequence

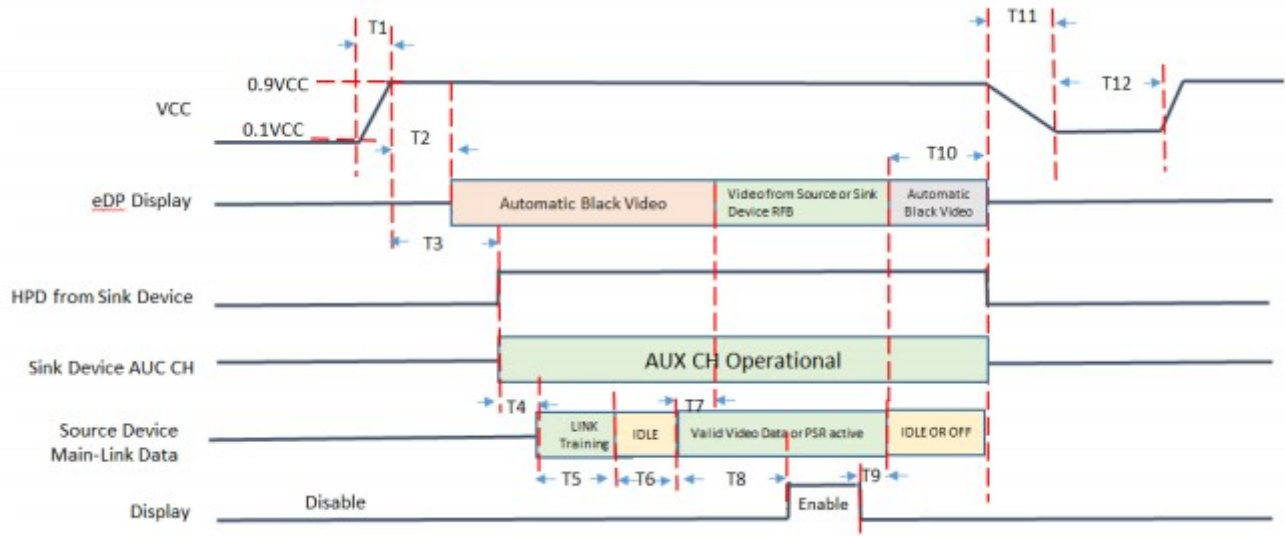

Timing Para	Description	Min.(ms)	Max.(ms)
T1	Power rail rise time,10%to90%	0.5	10
T2	VCC~Automatic Black Video	0	80
T3	VCC~HPD high	0	200
T4	HPD high~Link Training initialization	-	-
T5	Link Training	-	-
T6	Link idle	-	-
T7	Valid Video Delay(or PSR active from source to display)	0	50
T8	Valid Video~Display On	-	-
T9	Display Off~Display On	-	-
T10	Automatic Black Video~Power Off	150	500
T11	Power rail fall time,90%to10%	-	10
T12	Power Off Time	500	-



8. OPTICAL CHARACTERISTICS

The test of optical specifications shall be measured in a dark room (ambient luminance 1 lux and temperature = 25 ± 2°C) with the equipment of the Luminance meter system (Goniometer system and TOPCON BM-5) and the test unit shall be located at an approximate distance 50cm from the LCD surface at a viewing angle of θ and Φ equal to 0°. We refer to $\theta = 0^\circ$ ($= \theta 3$) as the 3 o'clock direction (the “right”), $\theta = 90^\circ$ ($= \theta 12$) as the 12 o'clock direction (“upward”), $\theta = 180^\circ$ ($= \theta 9$) as the 9 o'clock direction (“left”) and $\theta = 270^\circ$ ($= \theta 6$) as the 6 o'clock direction (“bottom”). While scanning θ and/or Φ , the center of the measuring spot on the display surface shall stay fixed.

Item	Symbol	Condition	Min	Typ.	Max	Unit	Note
Viewing Angle	θ_L	$Cr \geq 10$	-	80	--	deg	<u>Note 1</u>
	θ_R		-	80	--		
	ψ_T		-	80	--		
	ψ_B		-	80	--		
Contrast Ratio	Cr	$\theta = 0^\circ$	100000	--	--	--	<u>Note 2</u>
Response Time	$T_r + T_f$	FF=0°	--	--	1	ms	<u>Note 3</u>
Color Coordinate of CIE1931	W_x	$\theta = 0^\circ$	0.293	0.313	0.333	--	<u>Note 4</u>
	W_y		0.309	0.329	0.349		
	R_x		0.663	0.683	0.703		
	R_y		0.297	0.317	0.337		
	G_x		0.190	0.230	0.270		
	G_y		0.698	0.738	0.778		
	B_x		0.118	0.138	0.158		
	B_y		0.023	0.043	0.063		
Uniformity	U		75	--	--	%	
Color Gamut			90	100	--	%	<u>Note 5</u>
OLED lifetime	LT50*(With out lens 600 nit)	At 25°C, with white color pattern	15000	--	--	hrs	



Note 1: The definition of Viewing Angle

Refer to the graph below marked by θ and ϕ .

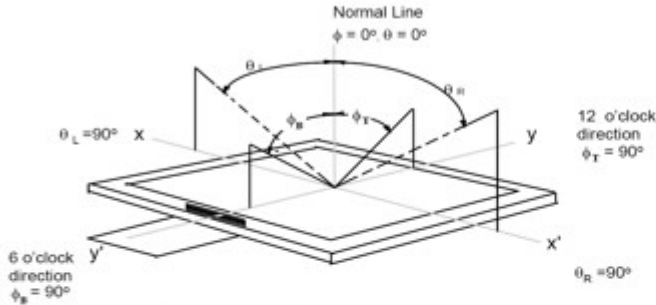

Note 2: The definition of Contrast Ratio

$$\text{Contrast Ratio (CR)} = \frac{\text{Luminance When LCD is at "White" state}}{\text{Luminance When LCD is at "Black" state}}$$

(Contrast Ratio is measured in optimum common electrode voltage)

Note 3: Definition of Response time. (Test LCD using RD80S or similar equipments):

The output sign also photo detector are measured when the input sign also are changed from "black" to "white" (Voltage falling time) and from "white" to "black" (Voltage rising time), respectively. The response time is defined as the time interval between the 10% and 90% of amplitudes. Refer to figures below.

Note 4: Color Coordinates of CIE 1931

The test condition is at ILED=20mA and measured on the surface of LCD module at 25°C.

Measurement equipment: CS2000 or similar equipments

The Color Coordinate (CIE 1931) is the measurement of the center of the display shown in below figure.

Note 5: Definition of Color of CIE Coordinate and NTSC Ratio.

$$S = \frac{\text{area of RGB triangle}}{\text{area of NTSC triangle}} \times 100\%$$

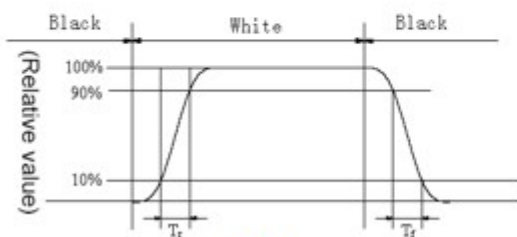

Note 3

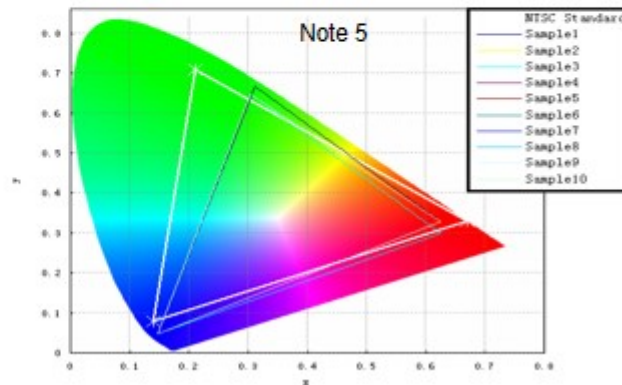



杭州中有触显智能科技
Hangzhou ZoYo Chuxian Intelligent Techonology



SKU.No.: DS10050

REV: A

PAGE: 10/28

NO: DSN1400E001A

10. PACKAGE

TBD



11. STANDARD SPECIFICATION FOR RELIABILITY:

No	Test Items	Conditions	Testing standard
1	High temperature storage Test	Ta= +70°C, 240 hours	IEC60068-2-1:2007 GB2423.2-2008
2	Low temperature storage Test	Ta=-30°C, 240 hours	IEC60068-2-1:2007 GB2423.1-2008
3	High temperature operation Test	Ta= +60°C, 240 hours	IEC60068-2-1:2007 GB2423.2-2008
4	Low temperature operation Test	Ta=-10°C, 240 hours	IEC60068-2-1:2007 GB2423.1-2008
5	High temperature & humidity (storage Test)	Ta= +60°C, 90%RH max, 240 hours	IEC60068-2-78:2001 GB/T2423.3-2006
6	ESD Test	C=150pF, R=330 Ω, 5 points/panel Air:±8KV, 5 times; Contact: ±4KV, 5times; (Environment:15°C~35°C, 30%~60%RH, 86Kpa~106Kpa)	EC61000-4-2:2001 GB/T17626.2-2006 Class C
7	Thermal shock Test	-20°C (30min/cycle) /+60°C (30min/cycle) 100cycle (1hr/cycle)	Start with cold temperature End with high temperature IEC60068-2-14:1984,GB2423.22-2002



12. QUALITY LEVEL

12.1 AMOLED Module of Characteristic Inspection

The environmental condition and visual inspection shall be conducted as below:

12.1.1 Test conditions:

OLED is not light, cold white fluorescent lamp, illumination 1000 ± 200 lux; OLED lighting source shall not be higher than 200lux, with black background around.

12.1.2 Inspection distance:

the standard observation distance of all surfaces of the tested object is $30\text{cm} \pm 5\text{cm}$.

12.1.3 Inspection angle:

the angle between the product and the horizontal plane is 45° , and the eyes are perpendicular to the inspection plane. During inspection, the product needs to rotate 45° up, down, left and right. The observation line of sight needs to be within the half section of the cone. The observation angle is 45° with the vertical axis of the product apex. The central axis of the cone must be standard and perpendicular to the product surface and pass through the fluorescent lamp; For non-conventional display defects (including but not limited to local bright lines or local floodlights), the observation angle is 75 degrees from the normal of the product surface; Full visual angle of appearance.

12.1.4 Inspection time:

the inspection time without lighting is at least 10-12 seconds; The time of OLED lighting inspection for each picture is 1~3 seconds. If the defect is still not visible within the specified time, the inspection piece is deemed to be qualified.

12.1.5 Test temperature: room temperature $15-35^\circ\text{C}$, ambient humidity: 20-75% RH.

12.1.6 Inspection tools:

12.1.6.1 ND Filter:

The ND Filter is placed at a distance of 2-3 cm above the defect for 2-3s to judge whether the defect is visible. As Figure below: (ND Filter is used to test mura isochromatic and light unevenness)

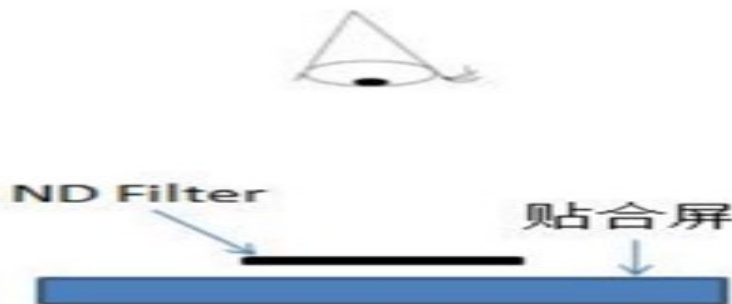

12.1.6.2 Point gauge (point gauge in the figure below is recommended), determination method: as shown in the figure, the point gauge film can cover is pass, and the point gauge film can not cover is Fail. For example, a maximum of 0.2mm same-color spot defect is allowed on the Class A surface, and the pass that can be covered by 0.2mm on the film, The one that can be covered is Fail.

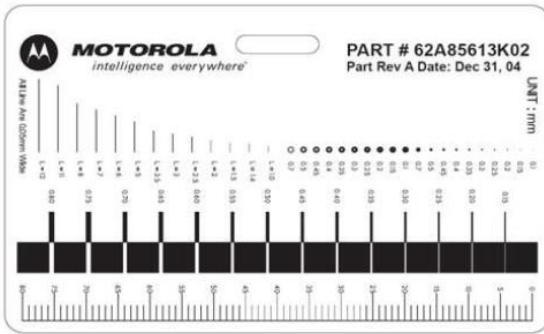

Imperfections of various shapes



Inspection Dot



Pass: Imperfection is smaller than the inspection dot

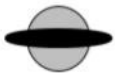

Fail: Imperfection is larger than the inspection dot

12.1.6.3 Microscopic examination: use 20-50 times adjustable microscope and 10-30 times test eyepiece.

12.1.6.4 Digital caliper: resolution 0.01mm.

12.1.6.5 Projector: anime microscope, 3D projector.

12.1.6.6 Judgment description:

12.1.6.6.1 The measurement accuracy shall refer to the specification definition. When the measurement equipment accuracy is higher than the specification definition, the measured value needs to be rounded to the precision defined by the specification. For example, the size of edge collapse is 0.20mm, and the thousandth is the reference position, which is rounded to 0.200mm~0.204mm is OK, ≥ 0.205 mm, it is judged as NG.



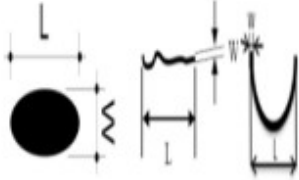

12.1.6.6.2 In addition to the tools used above, if additional inspection tools are needed to assist the judgment, they can only be carried out after the coordination of both parties.

12.1.6.6.3 Bad code and definition



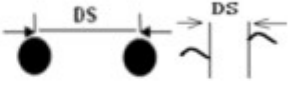
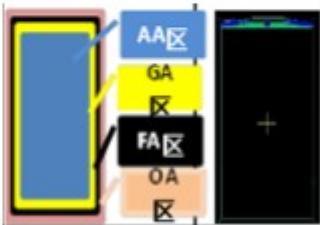

Code and name		legend	explain
N	Number	-	Visually calculate the number; The statistics of the total number of defects does not include the completely "omitted" part. For the column defined as "omitted" and "omitted", it is not counted as the number of defects if it meets the requirements, otherwise it is calculated as an independent defect.
L	Length (mm)		<p>Dot line distinguishing rule: L is the long side, W is the short side</p> <p>A. When $L > 3W$, handle as per line, otherwise handle as per point;</p> <p>B. When it is judged as line defect, S-shaped or C-shaped line appears, and the enclosed amount is less than 3/4 circle, it shall be treated as line defect; otherwise, it shall be treated as point defect, and the inner tangent circle shall simulate the size of point.</p>
W	Width (mm)		
S	Area (mm ²)	-	Surface gauge
D	Diameter (mm) $D=(L+W)/2$	-	Point diameter calculation: calculated by half of the sum of the long side and the short side, that is,



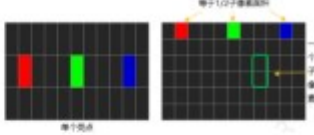
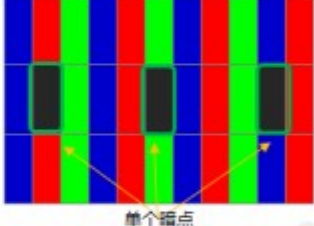
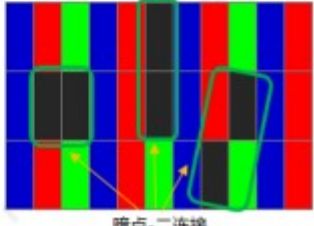
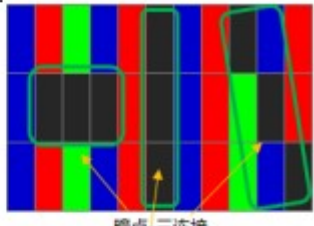

			$D=(L+W)/2$, where D represents the diameter of the point, L is the long side, and W is the short side;
H	Depth (mm)	-	Digital micrometer
DS	Distance (mm)		Distance between two points or between two lines
Schematic diagram of screen area		AA area: display area; GA area: GIP circuit area; FA area: Frit area; OA area: outside FA area	
Leader area		Screen GIP circuit area, screen data circuit area	
PAD Bangding District		COG/FOG Bonding alignment mark and Bonding Pad on LTPS substrate	
PAD Non-state area		Screen test pad, cutting area and lead-free area on LTPS substrate	
CT crimping area		Pin end screen test pad	



<p>Highlights</p>		<p>A single sub-pixel (or red, or green, or blue) of one pixel is called a point; The definition of bright spot is that in the environment of 200 ± 50 Lux, the pixels or dots seen by employees with naked eyes are always bright, and the bright spot is checked under the black screen</p>
<p>Scotoma</p>		<p>A single sub-pixel (or red, or green, or blue) of one pixel is called a point; A dark point is defined as a point that is not bright in a single sub-pixel seen with naked eyes in a 100% white picture under the environment of 200 ± 50 Lux.</p>
<p>Dark spot - two connection</p>		<p>Two adjacent sub-pixels under the magnifying glass are not bright at the same time (horizontal, vertical and oblique)</p>
<p>Dark Spot - Three Links</p>		<p>The adjacent R, G and B sub-pixels under the magnifying glass are not bright at the same time (horizontal, vertical and oblique)</p>
<p>CG monomer area division</p>		<p>AA: Front visible area, black ink internal area; A: Black ink area; B: Cover plate edge; The front defect that runs through the AA area and the A area shall be judged according to the specification of the strictest area, and the back defect shall be judged according to whether the AA area is visible.</p>
<p>Foreign matter highlights</p>	<p>-</p>	<p>Due to the foreign matter in the polarizer, the phenomenon that appears as a bright spot is called a foreign matter bright spot</p>

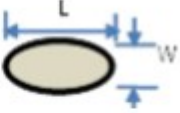
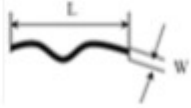

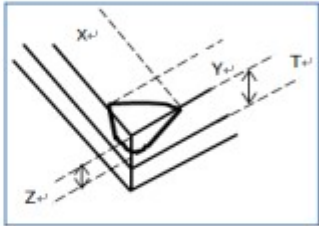
<p>point defect</p>		<p>There are bright spots and black spots in local positions, including but not limited to the internal dirt of the screen itself, pinholes, serrations, concave-convex spots, color spots, tiny bubbles, white spots, stains on the fitting of the polarizer, poor polarizer itself and other spot-like defects. Point defects are judged by diameter.</p>
<p>Linear defect</p>		<p>Linear impurities in the screen, including filaments, fibers, polarizer fitting impurities in the screen, and scratches on the surface of polarizer, etc. Linear defects are judged by length and width.</p> <p>Sensible scratch: also known as hard scratch, is a deep scratch on the surface, which is felt by hand.</p> <p>Senseless scratch: also known as fine scratch, no deep scratch on the surface, no feeling when touching.</p>
<p>Serrated defect</p>		<p>W: Distance from sawtooth crest to trough</p>
<p>Edge collapse/angle collapse</p>		<p>In the process of screen production, especially in the process of molding and cutting, the small glass missing at the glass edge is caused.</p> <p>X direction: parallel to FOG Pad or glass edge; Y direction: perpendicular to FOG Pad or glass edge; Z direction: screen thickness direction; T : The thickness of single-layer glass;</p>
<p>Pitting</p>	<p>-</p>	<p>In the unit area of 10mm * 10mm, the defect point with $D \leq 0.1\text{mm}$, $DS \geq 2\text{mm}$, and the number $N \geq 5$. If the customer has other requirements, follow the customer's requirements.</p>



Dirty	-	<p>Including handprints, oil stains, fingerprints, stains, white fog and other undesirable phenomena. It is divided into erasable dirt and non-erasable dirt. Use a dust-free cloth dipped in alcohol, which can not be erased as non-erasable dirt. Wipable dirt is determined as follows:</p> <p>A. Dry dust-free cloth can be directly erased;</p> <p>B. Wipe with clean cloth dipped with anhydrous alcohol</p> <p>Press the alcohol-stained dust-free cloth on the dry dust-free cloth twice to absorb excess alcohol;</p> <p>Wipe back and forth with a dust-free cloth twice, and the dirt can be removed.</p>
-------	---	---

12.2 Sampling Procedures for Each Item Acceptance Table

Critical Defect (CR): any defect that directly or indirectly affects human health and safety, or the function of the product is lost.

Major Defect (MA): directly or indirectly affect the product function, or make part of the product function lost, and other customers do not acceptable defects.

Minor Defect (MI): appearance defect that does not affect product function and can be accepted by customers.

Defect Type	Sampling Procedures	AQL
Critical Defect (CR)	Take the normal inspection solution of the sampling plan of GB/T2828.1-2012 Inspection level II	0.065
Major Defect (MA)	Take the normal inspection solution of the sampling plan of GB/T2828.1-2012 Inspection level II	0.65
Minor Defect (MI)	Take the normal inspection solution of the sampling plan of GB/T2828.1-2012 Inspection level II	1.0

12.3 Telecommunications Inspection Item

category	NO.	Inspection items	Inspection specification	test mode	defect type
	1	Display exception	not allow	visual	CR



Poor function	2	No display	not allow	visual	CR
	3	The picture flickers	not allow	visual	MA
TP function	4	TP test NG	not allow	visual	MA
Dot	5	Bright dot	not allow	visual	MI
	6	Partial Bright dot	ND6% or reference limit sample	visual	MI
	7	Dark dot	1.D≤0.15mm, ignored; 2.0.15mm < D≤ 0.2mm, DS ≥ 10mm, N ≤ 10; 3.D > 0.2mm,not allowed;	Visual inspection, Flinka	MI
Line	8	Bright line	not allow	visual	MA
	9	Dark line	not allow	visual	MA
	10	Slightly bright line	not allow	visual	MA
Mura	11	horizontal mura	No control under W64/127 screen; The 4%ND Filter on the 255 screen determines that the invisible is OK and the visible is NG.	Visual ND Filter/limit sample	MI
	12	vertical mura	No control under W64/127 screen; The 4% ND Filter on the 255 screen determines that the invisible is OK and the visible is NG.	Visual ND Filter/limit sample	MI
	13	White spot	No control under W64/127 screen; The 4% ND Filter on the 255 screen determines that the invisible is OK and the visible is NG.	Visual ND Filter/limit sample	MI
	14	Black spot	No control under W64/127 screen; The 4% ND Filter on the 255 screen determines that the invisible is OK and the visible is NG.	Visual ND Filter/limit sample	MI
	15	Color mura	4% ND Filter in W64/255 screen determines that the invisible is OK and the visible is NG	Visual ND Filter/limit sample	MI



	16	snowflake	No control under W64/127 screen; The 4% ND Filter on the 255 screen determines that the invisible is OK and the visible is NG.	Visual ND Filter/limit sample	MI
	17	Twill mura	No control under W64/127 screen; The 4% ND Filter on the 255 screen determines that the invisible is OK and the visible is NG.	Visual ND Filter/limit sample	MI
	18	Newtonian ring	No control under W64/127 screen; The 4% ND Filter on the 255 screen determines that the invisible is OK and the visible is NG.	Visual ND Filter/limit sample	MI
	19	Uneven transition	Reference homogeneity standard to assist in judgment; The 4% ND Filter in the W64/255 screen determines that the invisible product is OK and the visible product is NG.	Visual ND Filter/limit sample	MI
<p>1、 Mura all specify the screen judgment. For example, if the ELA mura judgment standard is 255, the ELA mura will only be judged on the W255 screen.</p> <p>2、 Other types of mura have a low adverse effect rate and low incidence. According to the 4% ND Filter in the W64/255 screen, the invisible products are OK and the visible ones are NG.</p>					
Dot/line of foreign material	20	Dot/line defects (foreign material, black white dot, scratch, bubble, etc.)	Same point/line specifications	Visual inspection/Flinka	MI

12.4 Appearance Inspection Item

NO.	Inspection items	Surface Area	Inspection specification	test mode	defect type
1	Broken glass	AA/OA	not allow	visual	MA
2	crack	AA/OA	not allow	visual	MA
3	Edge collapse/corner	AA/OA	<p>1. $Y \leq 0.15\text{mm}$, X and N are ignored;</p> <p>2. $0.15 < Y \leq 0.4\text{mm}$, $X \leq 2\text{mm}$, N is ignored;</p> <p>3. $Y > 0.4\text{mm}$, not allowed;</p> <p>4. $Z \leq t$, without damage to Frit body;</p>	Visual inspection, Flinka	MI



4	flange	AA/OA	<p>1. $Y \leq 0.2\text{mm}$, X is uncontrolled; 2. $Y > 0.2\text{mm}$, not allowed;</p>	Visual inspection, Flinka	MI
5	Glass warp	Whole area	<p>The product is placed horizontally on the front and back, and the lifting height at one end (plug gauge) $\leq 0.6\text{mm}$</p>	Visual inspection, Flinka	MI
6	Pin dirty	Bongding area	No control	visual	MI
7	Pin scratch	Bongding area	Scratches and whitening are found by visual inspection, and need to be rechecked with a microscope. The broken lead is not allowed, and the overlap is not allowed Note: CT pad area and pin non-bonding area are not controlled	visual	MI
8	PF film bump	LTPS	Touch is not allowed	visual	MI
9	PF film pinholes/pits	LTPS	No control	visual	MI
10	PF film scratch	LTPS	1. No scratch, no control; Scrape through, $L < 10\text{mm}$; 2. The film shall be scraped through the exposed glass surface, referring to the lack of glue of PF film;	Visual inspection, Flinka	MI
11	PF film lacks glue	LTPS	$50 > 5\text{mm}$, $W > 5\text{mm}$ not allowed	Visual inspection, Flinka	MI
12	PF membrane is dirty	LTPS	Wipable dirt needs to be wiped, and non-wipe dirt refers to the color difference of PF film;	visual	MI
13	PF film overflow	LTPS	1. Edge overflow $W < 0.2\text{mm}$, acceptable; 2. $W > 0.2\text{mm}$, not allowed;	Visual inspection, Flinka	MI



14	Color difference/stain (no convex touch)	LTPS	No control				visual	MI
15	PF film gluing offset	LTPS	1. Step area is not allowed; 2. Except for the step area, the rest shall be controlled by $0.5 \pm 0.2\text{mm}$;				Visual inspection, Flinka	MI
16	Screen body is dirty	LTPS	1. The front can be wiped and the dirt can be wiped, and the polarizer of the dirt cover cannot be wiped; 2. The back is not controlled;				visual	MI
17	point defect	AA	D (mm)	DS (mm)	Acceptable number		Visual inspection, Flinka	MI
			$D \leq 0.15\text{mm}$	/	Ignore			
			$0.15\text{mm} < D \leq 0.2\text{mm}$	$DS \geq 10$	$N \leq 10$			
18	Linear defect/foreign matter linear/non-inductive scratch	AA	W (mm)	L (mm)	DS (mm)	Acceptable number	Visual inspection, Flinka	MI
			$W \leq 0.03$	$L \leq 5$	≥ 10	ignore		
			$0.03 < W \leq 0.05$	$L \leq 2$	≥ 10	ignore		
			$0.03 < W \leq 0.05$	$2 < L \leq 5$	≥ 10	$N \leq 4$		
			$W > 0.05$	-	/	Not allowed		
			-	$L > 5$	/	Not allowed		
19	Point/Line defects	Camera hole area/Blind hole area	D(mm)		Acceptable number		Visual inspection, Flinka	MI
			$D \leq 0.15$		ignore			
			$0.15 < D \leq 0.2$		ignore			
			$D > 0.2$					
20	Newton rings (Blind hole area)	Camera hole area/Blind hole area	Not control				Visual inspection	MI
21	offset	Camera hole	The metal ring extends inward 0.1mm ,ignore				Visual inspection	MI



		area/Blind hole area			
22	Blind hole color bias(same color)	Camera hole area/Blind hole area	Functional requirements such as transmittance and PV value are met, not control appearance	Visual inspection	MI
23	Protective film scratch	Whole area	No control under no hurt baby	Visual inspection	MI
24	Protective film starved/overflow glue/burr	Whole area	No control under no hurt baby	Visual inspection	MI
25	Dirt inside the protective film	Whole area	Not allowed	Visual inspection	MI
26	Easy to tear	Cover front	Function is invalid, damaged, leaked not allowed Wrinkles, bumps, dirt, punching bad, burr, overflow glue is not controlled	Visual inspection	MI
27	Polarizer edge overflow	AA	$W \leq 0.35\text{mm}$, Not control; $W > 0.35\text{mm}$, Not allowed.	Visual inspection, Flinka	MI
28	Polarizer concave convex point	AA	convex point: $D \leq 0.2\text{mm}$ or refer to limit sample concave point: $D \leq 3\text{mm}$, $DS \geq 10\text{mm}$, $N \leq 3$ or refer to limit sample	Visual inspection, Flinka	MI
29	Polarizer fold / indentation	AA	Does not affect the display as OK or refer to limit sample;	Visual inspection	MI
30	Polarizer chromatism	AA	No control	Visual inspection	MI
31	IC chip	IC	Not allowed	Visual inspection	MI
32	FPC body defect	FPC	1. The parts on the FPC must be consistent with the product BOM table, and there are incorrect, multiple, or missing parts, which are not allowed; Polarities such as capacitors and inductors should not be soldered backwards or crooked; 2. FPC scratches/scratches are based on the absence of exposed copper; 3. Creases/Indentations: Indentations in the circuit area should not cause the back of the	Visual inspection	MI



			<p>covering film to turn white; Non line area indentation should not cause FPC damage</p> <p>4. Except for the golden finger. FPC foreign object: a. Spot shape: $D \leq 0.5\text{mm}$, $N \leq 3$; b. Linear: length and width $\leq 0.3 * 5\text{mm}$;</p>		
33	FPC gold finger defect	Golden Finger Region	<p>1. Golden finger cracking: The length and width of the crack/damage at the top of the golden finger \leq the line width;</p> <p>2. Gold finger copper leakage: $W \leq 1/3$ line width, $L \leq$ line width, unlimited quantity</p> <p>3. Gold finger gap $W1 \leq 1/3$ line width W, length $L1 \leq 1/2$ line width W, unlimited quantity, all of the above conditions are met and allowed;</p> <p>4. Gold finger pressure/scratch should not expose copper, there should be no unevenness, and there should be no depth visible to the naked eye, which does not affect assembly and is acceptable;</p> <p>5. Gold fingers should not have sharp creases or dead folds;</p> <p>6. FPC gold fingers should not have oxidation, blackening, burns, or browning;</p>	Visual inspection	MI
34	connector	connect or	<p>There should be no tin or residual solder beads on the connector, and there should be no tin connection on the connector pins; PIN deformation shall be controlled within 0.05mm; Does not affect the lighting function; Visual inspection of pin breakage, pin detachment, and deformation of the outer frame is not allowed;</p>	Visual inspection	MI
35	Insulating tape	Bonding area	<p>There must be no obvious wrinkles or bubbles</p>	Visual inspection	MI
		Component area	<p>1. Scratches and glue splashes are uncontrollable;</p> <p>2. Do not wipe dirt or dirt;</p> <p>3. The offset of the insulation tape should not exceed the edge of the product, and other requirements should be determined based on the drawing;</p> <p>4. Burr edges, no control over glue overflow;</p>		



			5. Damaged, incomplete, or missing labels are not allowed;		
36	Composite tape	All	<p>1. It is not allowed for the composite tape to leak out of the edge of the screen body;</p> <p>2. Folding of composite tape, light leakage during assembly, or affecting assembly and thickness are not allowed;</p> <p>3. Damaged composite tape is not allowed;</p> <p>4. The size of the composite tape cutting defect does not meet the requirements of the drawing and cannot be controlled;</p> <p>5. Composite tape should not be wiped with dirt or foreign objects, and foreign objects should follow the dotted line standard;</p> <p>6. The burrs of the composite tape should not exceed the edge of the screen body, regardless of control;</p> <p>8. Composite adhesive tape with no control over glue splashes or overflow;</p> <p>9. Composite tape bubbles: $D \leq 5\text{mm}$, N not included;</p> <p>10. Composite tape bumps: acute angle bumps $D \leq 0.3\text{mm}$, $N \leq 3$; Smooth concave convex points $D \leq 0.8\text{mm}$, $N \leq 3$;</p> <p>11. Composite tape foreign object (foreign object between copper foil and blue film): $D \leq 0.3\text{mm}$, $N \leq 3$;</p> <p>12. Edge sawtooth of composite tape: $0.5 * 3\text{mm}$, $N \leq 3$;</p> <p>13. The color difference of the protective film in the composite tape is not controlled;</p> <p>14. Copper foil indentation and dead bending in composite tape are not allowed, which does not affect assembly and thickness control; Or reference limit sample;</p> <p>15. No control of foreign objects/dents in copper foil in composite tape;</p>	Visual inspection	MI
37	OCA overflow	All	<p>Not allowed within AA area;</p> <p>Externally visible: Control standard $\leq 0.15\text{mm}$</p>	Visual inspection	MI





38	Sealing glue	Pin	<p>1. Broken adhesive is not allowed, and the circuit cannot be exposed.</p> <p>2. The thickness of the colloid shall not be higher than the POL surface.</p> <p>3. Bubble diameter<1mm.</p> <p>4. Other: According to the drawings and work instructions.</p>	Visual inspection	MI
39	Conductive cloth	All	<p>1. Conductive cloth dirt: $D \leq 5\text{mm}$, $N \leq 2$;</p> <p>2. Conductive cloth bubbles: $D \leq 2\text{mm}$, $N \leq 2$;</p> <p>3. Conductive cloth foreign object: $D \leq 1\text{mm}$, $N \leq 3$;</p> <p>4. Folding of conductive fabric: $N \leq 2$;</p>	Visual inspection	MI
40	Copper foil	All	<p>Copper foil sticking is not allowed to leak out of the edge of the screen body; Abnormal color of copper foil refers to standard samples/sealed samples, and damage is not allowed. Soft scratches on the surface are not controlled.</p>	Visual inspection	MI
41	QR code	QR code	<p>It is not allowed to be unable to scan or difficult to scan (recognition can only be achieved after three consecutive scans), with a clear appearance, no blurring, missing printing, and other defects</p>	Visual inspection	MI
42	Package	Other	<p>Products should put into the anti-static trays, with non-overlapping, and the trays should be staggered placed.</p>	visual	-
			<p>Different products cannot be mixed into the same inner package.</p>		
			<p>The package should not have obvious deformation or breakage .The printing labels type and quantity are correct.</p> <p>The package should have QC signature. ROHS label is needed if the product is under ROHS control.</p>		
43	Boundary dimension NG	Other	<p>It is not allowed to exceed the dimensional tolerance required by the specifications and drawings</p>	Calipers, measuring instruments	-

12.5 Inspection picture library

Serial number	picture	Picture name	Mainly judged as defective	remarks
---------------	---------	--------------	----------------------------	---------



1		W_GRAD(64) 64 gray scale	Point/line type, foreign matter point/line, mura type	/
2		W_GRAD(128) 128 gray scale	Point/line type, foreign matter point/line, mura type	/
3		WHITE white	Point/line type, foreign matter point/line, mura type	/
4		Black black	Bright spot, bright line, dark mura	/
5		RED red	Point type, line type, foreign matter point/line	/
6		GREEN green	Point type, line type, foreign matter point/line	/
7		BLUE blue	Point type, line type, foreign matter point/line	/

Note: The actual sequence and lock seconds of the screen can be adjusted according to the customer's requirements and the needs of the factory.



13. PRECAUTIONS FOR USE OF AMOLED MODULES

13.1 Handling Precautions:

- 13.1.1 The display panel is made of glass. Do not subject it to a mechanical shock by dropping it from height.
- 13.1.2 Do not press down the screen or the adjoining areas too hard because the color tone may be shifted.
- 13.1.3 The polarizer covering the display surface of the AMOLED module is soft and easily scratched. Handle this polarizer carefully.
- 13.1.4 If the display surface is contaminated, blow on the surface and gently wipe it with a soft dry cloth. If it is still not completely clear, moisten the cloth with ethyl alcohol.
- 13.1.5 Solvents may damage the polarizer. Do not use water, ketone or aromatic solvents except ethyl alcohol.
Do not attempt to disassemble the AMOLED Module.
- 13.1.6 If the logic circuit power is off, do not apply the input signals.
- 13.1.7 To prevent destruction from static electricity, be careful to maintain an optimum working environment.
- 13.1.8 Be sure to make yourself in contact with the ground when handling with the AMOLED Modules.
- 13.1.9 Tools required for assembly, such as soldering irons, must be properly ground.
- 13.1.10 To reduce the generation of static electricity, do not conduct assembly or other work under dry conditions.
- 13.1.11 To protect the display surface, the AMOLED Module is coated with a film. Be careful when peeling off this protective film, because static electricity may generate.

13.2 Storage Precautions:

- 13.2.1 When storing the AMOLED modules, be sure that they are not directly exposed to the sunlight or the light of fluorescent lamps.
- 13.2.2 The AMOLED modules should be stored under the storage temperature range. If the AMOLED modules will be stored for a long time, the recommended condition is:
Temperature: 0°C~40°C Relatively humidity: ≤80%
- 13.2.3 The AMOLED modules should be stored in the room without acid, alkali or harmful gas.

13.3 Transportation Precautions:

- 13.3.1 The AMOLED modules should not be suffered from falling and violent shocking during transportation. Besides, excessive press, water, damp and sunshine, should be avoided.