

**PROPRIETARY NOTE**

THIS SPECIFICATION IS THE PROPERTY OF BOE HF AND SHALL NOT BE REPRODUCED OR COPIED WITHOUT THE WRITTEN PERMISSION OF BOE HF AND MUST BE RETURNED TO BOE HF UPON ITS REQUEST



SPEC. NUMBER	PRODUCT GROUP TFT- LCD	REV. PA	ISSUE DATE 2A2A.1A	PAGE 1 OF 31
--------------	---------------------------	------------	-----------------------	-----------------

**B3 GV185FHM-N10 Product Specification Rev.P0**

---

SUPPLIER	HEFEI BOE Optoelectronics Technology CO., LTD
FG-Code	<b>GV185FHM-N10-3M30</b>

ITEM	BUYER SIGNATURE	DATE
_____	_____	_____
_____	_____	_____
_____	_____	_____

ITEM	SUPPLIER SIGNATURE	DATE
Prepared	_____	_____
Reviewed	_____	_____
Approved	_____	_____



**PROPRIETARY NOTE**

THIS SPECIFICATION IS THE PROPERTY OF BOE HF AND SHALL NOT BE REPRODUCED OR COPIED WITHOUT THE WRITTEN PERMISSION OF BOE HF AND MUST BE RETURNED TO BOE HF UPON ITS REQUEST



SPEC. NUMBER

PRODUCT GROUP  
TFT- LCD

REV.

ISSUE DATE

PAGE  
OF 31

## Contents

No.	Items	Page
1.0	General Description	4
2.0	Absolute Maximum ratings	6
3.0	Electrical specifications.	7
4.0	Interface Connection	10
5.0	Signal Timing Specifications	13
6.0	Signal Timing Waveforms Of Interface Signal	15
7.0	Power Sequence	17
8.0	Optical specifications.	18
9.0	Mechanical Outline Dimension	22
10.0	Reliability Test	24
11.0	Precautions	25
12.0	Label	29
13.0	Packing information	31

### 1.0 GENERAL DESCRIPTION

GV185FHM-N10-3M30 is a color active matrix TFT LCD module using amorphous silicon TFT's (Thin Film Transistors) as active switching devices. This module has a 18.5 inch diagonally measured active area with FHD resolutions (1920 horizontal by 1080 vertical pixel array). Each pixel is divided into RED, GREEN, BLUE dots which are arranged in vertical stripe and this module can display 16.7 M colors.

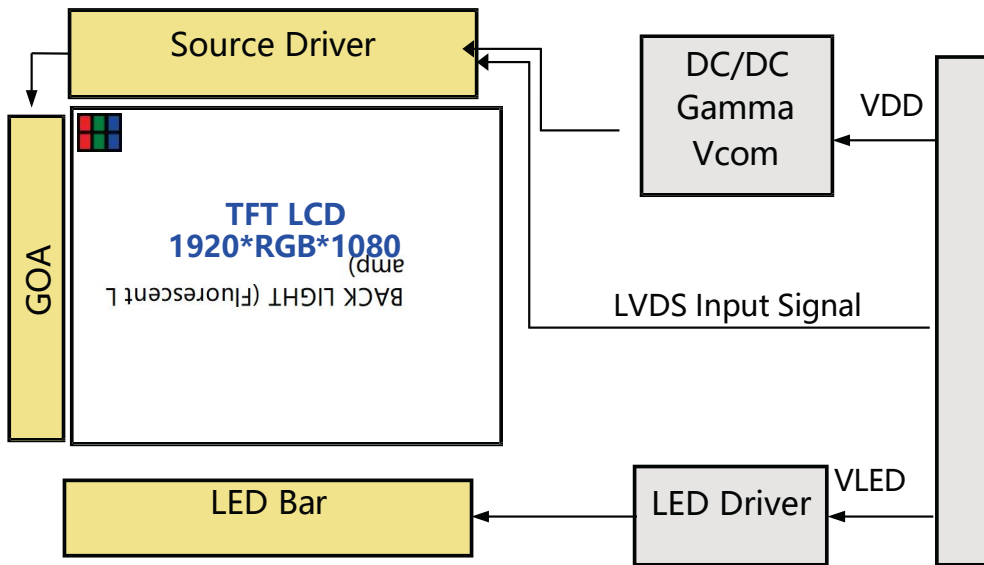

#### 1.0.2 Features

- LED back-light
- LVDS interface
- RoHS Compliant
- 16.7M color depth

#### 1.0.3 Application

- Video Phone/IP Phone/Smart Key/ e-cigarettes etc.

## 1.0.4 General Specification

&lt; Table 1. General Specifications &gt;

Parameter	Specification	Unit	Remarks
Active area	408.96 (H) × 230.04(V)	mm	
Number of pixels	1920(H) × 1080(V)	Pixels	
Pixel pitch	0.213(H) × 0.213 (V)	mm	
Pixel arrangement	RGB Vertical stripe		
Display colors	16.7M(8bit)	Colors	
Display mode	Normally Black		
Dimensional outline	430.4 (H) × 254.6(V) × 12(D) typ.	mm	
Weight	1800	g	
Surface treatment	AG25, 3H		
Back-light	Edge side, 1-LED Lighting Bar Type		44*LED

### 2.0 ABSOLUTE MAXIMUM RATINGS

The followings are maximum values which, if exceed, may cause faulty operation or damage to the unit. The operational and non-operational maximum voltage and current values are listed in Table 2.

< Table 3. Environment Absolute Maximum Ratings> [Ta =25±2 °C]

Parameter	Symbol	Min.	Type.	Max.	Unit	Remarks
Back-light Power Supply Voltage	HV <sub>DDOUT</sub>	-	33V	-	V	Ta = 25 °C Note 1&2
Back-light LED Current	I <sub>HVDD</sub>	-	300	360	mA	
Back-light LED Reverse Voltage	V <sub>R</sub>	-	-	-	V	
Power Supply Input Voltage	VCC	3.5	5	5.8	V	

Note:

1. These range above is maximum value not the actual operating temperature . Actual Operating temperature is no more than 40°C and temperature refers to the LCM surface temperature ;
2. BOE is not responsible for product problems beyond the use conditions.
3. When the ambient temperature is T °C, the surface temperature of Panel can not exceed (T+15)°C.

### 3.0 ELECTRICAL SPECIFICATIONS

#### 3.0.1 TFT LCD Module

< Table 4. LCD Module Electrical Specifications >

[Ta =25±2 °C]

Parameter	Symbol	Values			Unit	Notes
		Min	Typ	Max		
Power Supply Input Voltage	V <sub>DD</sub>	4	5	5.8	V	Note 1
Power Supply Current	I <sub>DD</sub>	-	500	-	mA	
LED Driver Power Supply Voltage	H <sub>VDD</sub>	10.8	12	12.6	V	Note 2
LED Driver Power Supply Current	I <sub>HVDD</sub>	-	1000	-	mA	
LED Power Consumption	P <sub>LED</sub>	-	12	-	W	
Positive-going Input Threshold Voltage	V <sub>IT+</sub>	-		+100	mV	V <sub>com</sub> = 1.2V typ.
Negative-going Input Threshold Voltage	V <sub>IT-</sub>	-100		-	mV	
Differential input common mode voltage	V <sub>com</sub>		1.2		V	V <sub>IH</sub> =100mV, V <sub>IL</sub> =-100mV

Notes : 1. The supply voltage is measured and specified at the interface connector of LCM.  
The current draw and power consumption specified is for 5V at 25 °C  
Max value at Black Pattern

2. Calculated value for reference  $I_{LED} \times V_{LED} \div 0.85 = P_{LED}$

### 3.1 Back-light Unit

< Table 6. LED Driving guideline specifications >

Ta=25+/-2°C

Parameter		Min.	Typ.	Max.	Unit	Remarks	
Power supply voltage for Back light	V <sub>LED</sub>		33		V		
Power supply Current for Back light	I <sub>LED</sub>	-	300	-	mA		
Power supply for Back light	P <sub>LED</sub>	-	10	-	W	Note 1	
EN Control Level	Backlight on	V <sub>ENH</sub>	2.5	-	-	V	EN logic high voltage
	Backlight off	V <sub>ENL</sub>	-	-	0.8	V	EN logic low voltage
PWM Control Level	PWM High Level	V <sub>PML</sub>	2.5	-	-	V	
	PWM Low Level	V <sub>PML</sub>	-	-	0.8	V	
PWM Control Frequency	F <sub>PWM</sub>	0.15	-	1	KHz		
Duty Ratio	-	5	-	100	%		

Notes : 1. Calculator Value for reference  $I_{LED} \times V_{LED} = P_{LED}$

2. The LED Life-time define as the estimated time to 50% degradation of initial luminous under the condition of the ambient temperature of 25°C.



## 4.0 INTERFACE CONNECTION.

### 4.0.1 Electrical Interface Connection

The electronics interface connector IS100-L30R-C23 (UJU) or equivalent.

The LED connector is CI4205M2HRD-NH or equivalent.

The connector interface pin assignments are listed in Table 7 and 8.

<Table 7. Pin Assignments for the Interface Connector>

Pin No.	Symbol	Description	remark
1	RxOINA-	LVDS data input	
2	RxOINA+	LVDS data input	
3	RxOIN1-	LVDS data input	
4	RxOIN1+	LVDS data input	
5	RxOIN2-	LVDS data input	
6	RxOIN2+	LVDS data input	
7	VSS	Ground	
8	RxOCLKIN-	LVDS clock input	
9	RxOCLKIN+	LVDS clock input	
1A	RxOIN3-	LVDS data input	
11	RxOIN3+	LVDS data input	
12	RxEINA-	LVDS data input	
13	RxEINA+	LVDS data input	
14	VSS	Ground	
15	RxEIN1-	LVDS data input	
16	RxEIN1+	LVDS clock input	
17	VSS	Ground	
18	RxEIN2-	LVDS clock input	
19	RxEIN2+	LVDS clock input	
2A	RxECLKIN-	LVDS clock input	
21	RxECLKIN+	LVDS clock input	
22	RxEIN3-	LVDS clock input	
23	RxEIN3+	LVDS clock input	
24	VSS	Ground	

Pin No.	Symbol	Description	remark
25	SCL	I2C BUS	Only BOE use
26	SDA	I2C BUS	Only BOE use
27	WP	EEPROM write EN	Only BOE use
28	VCC	Power supply(5V)	
29	VCC	Power supply(5V)	
3A	VCC	Power supply(5V)	

<Table 8. Pin Assignments for the LED Connector>

Terminal	Symbol	Functions
Pin No.	Symbol	Description
1	VLED	12V
2	GND	GND
3	Enable	5V-On / AV-Off
4	Dimming	PWM Dimming
5	NC	No Connection

### 4.2 Data Input Format

**Figure 5. Pixel Format**

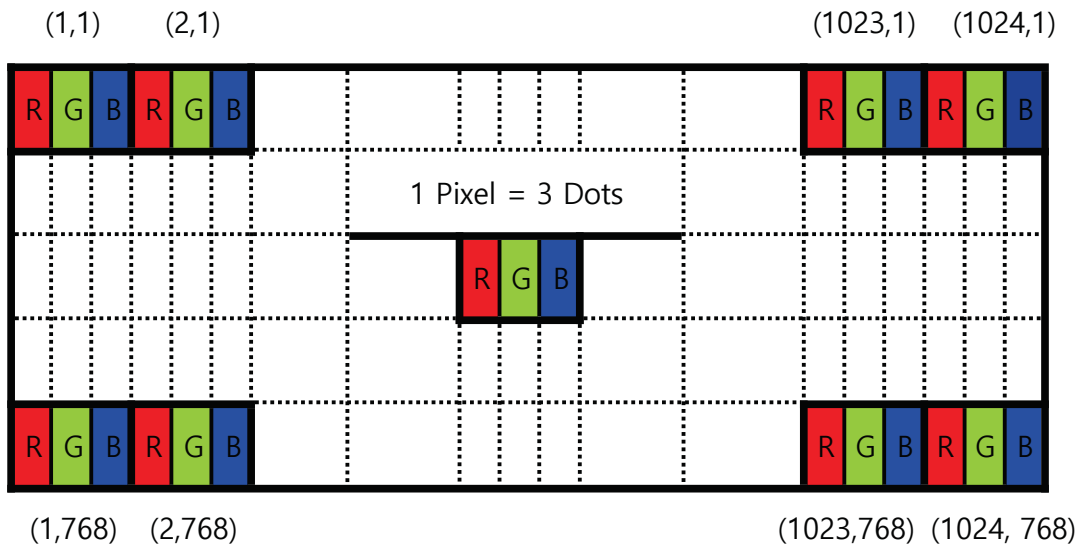

Display Position of Input Data (V-H)

**Figure 6. Scan direction**

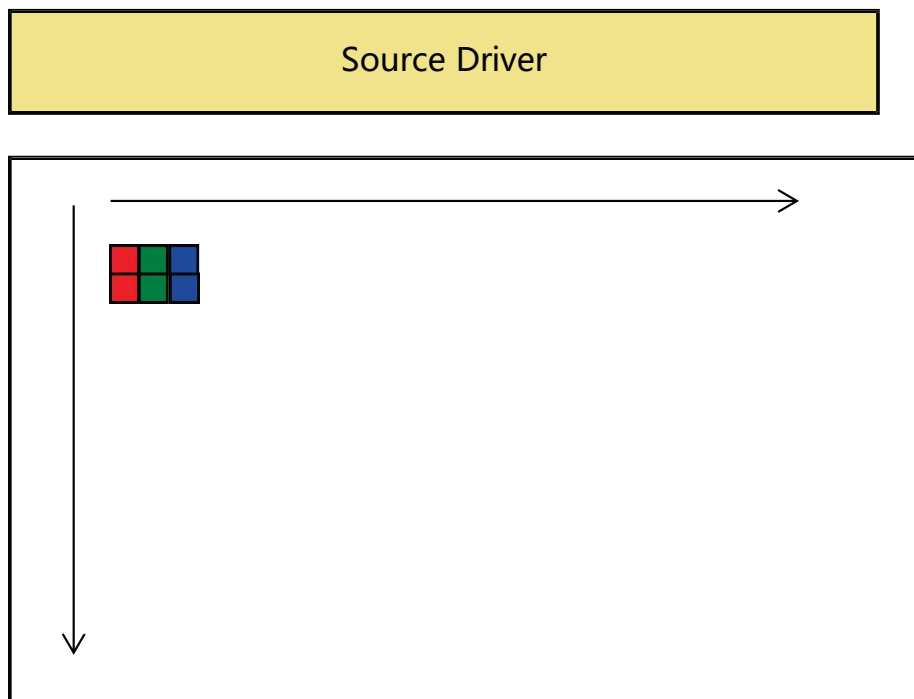

### 5.0 SIGNAL TIMING SPECIFICATION

5.0.1 The **XX-FG code** is operated by the DE only.

Item	Symbols		Min	Typ	Max	Unit	Note
DCLK	Period	tCLK	9.5	-	25	ns	Note 1
	Frequency	-	40	-	105	MHz	
Hsync	Period	tHP	990	1040	-	tCLK	
	Horizontal Valid	tHV	-	960	-	tCLK	
	Horizontal Blank	tHB	30	80	-	tCLK	
Vsync	Period	tVP	1100	1125	1138	tHP	
	Vertical Valid	tVV	-	1080	-	tHP	
	Vertical Blank	tVB	30	45	58	tHP	
	Frequency	fV	45	60	75	Hz	
LVDS Receiver clock	Input spread spectrum ratio	SSr	-	1.5	2	%	Note 2
	spread spectrum modulation frequency	Fssm	-	-	100	KHZ	

Note 1: The DCLK range at last line of V-blanking should be set in 0-H-active/2.

Note 2: The SSGG(spread Spectrum Clock Generator) is defined as following figure:

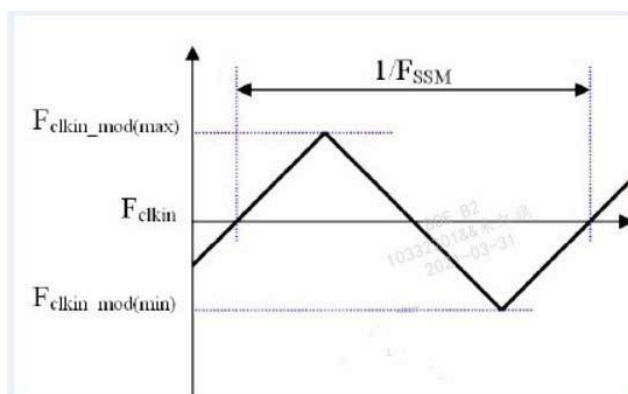

### 5.02 LVDS Rx Interface Timing Parameter

The specification of the LVDS Rx interface timing parameter is shown in Table 4.

<Table 9. LVDS Rx Interface Timing Specification>

Item	Symbol	Min	Typ	Max	Unit	Remark
CLKIN Period	tRCIP	9.5		25	nsec	
Input Data 0	tRIP1	-0.4	0.0	+0.4	nsec	
Input Data 1	tRIP0	tRCIP/7-0.4	tRCIP/7	tRCIP/7+0.4	nsec	
Input Data 2	tRIP6	2 × tRCIP/7-0.4	2 × tRCIP/7	2 × tRCIP/7+0.4	nsec	
Input Data 3	tRIP5	3 × tRCIP/7-0.4	3 × tRCIP/7	3 × tRCIP/7+0.4	nsec	
Input Data 4	tRIP4	4 × tRCIP/7-0.4	4 × tRCIP/7	4 × tRCIP/7+0.4	nsec	
Input Data 5	tRIP3	5 × tRCIP/7-0.4	5 × tRCIP/7	5 × tRCIP/7+0.4	nsec	
Input Data 6	tRIP2	6 × tRCIP/7-0.4	6 × tRCIP/7	6 × tRCIP/7+0.4	nsec	

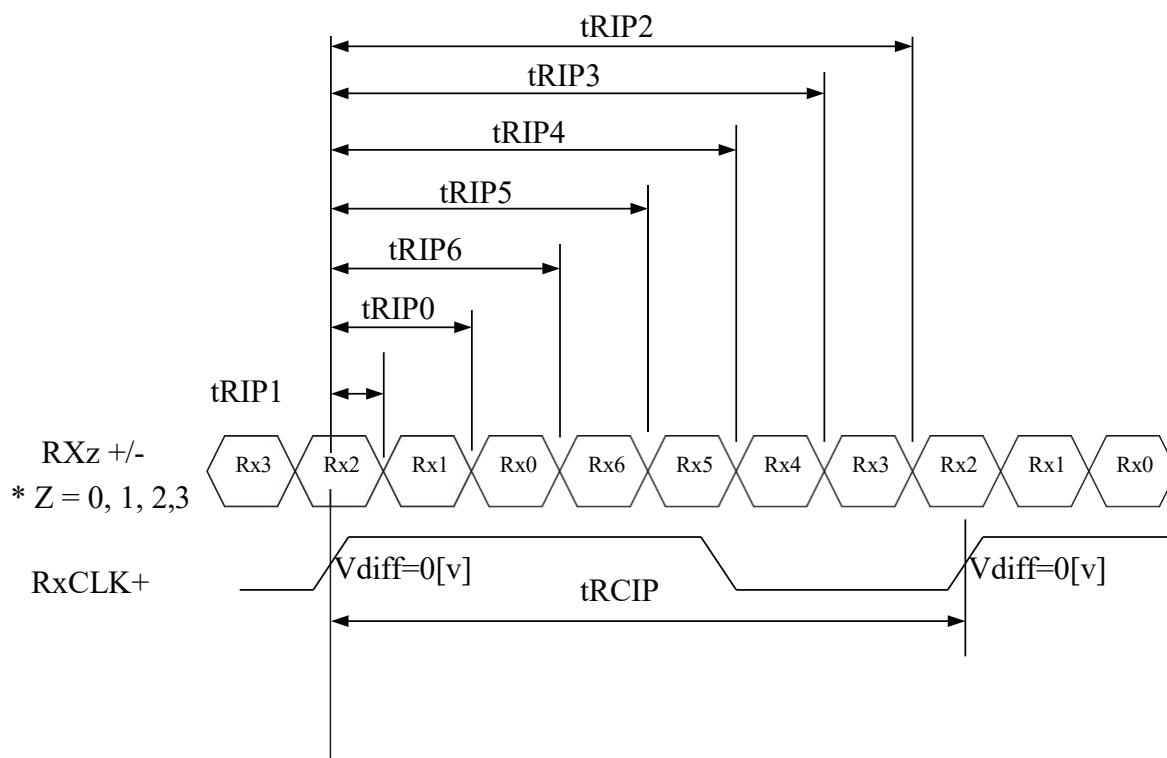

\* Vdiff = (RXz+)-(RXz-),.... ,(RXCLK+)-(RXCLK-)

### 6. SIGNAL TIMING WAVEFORMS OF INTERFACE SIGNAL

#### 6.01 Sync Timing Waveforms

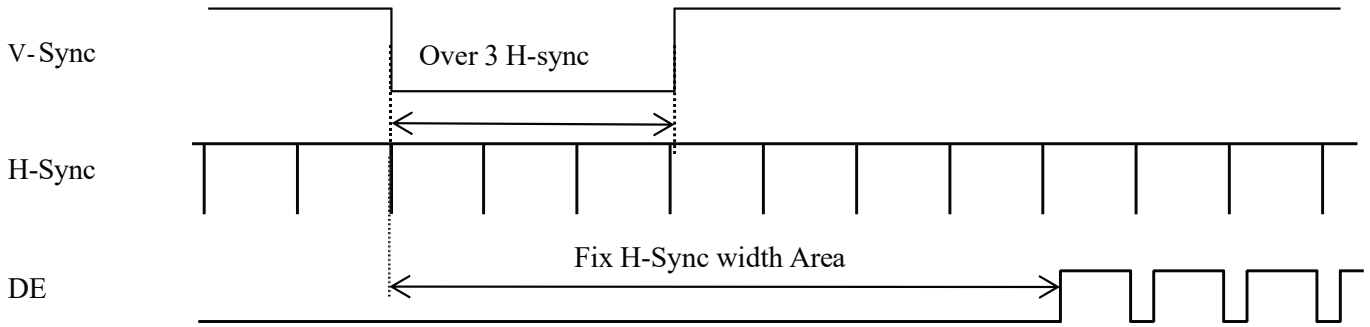

- 1) Need over 3 H-sync during V-Sync Low
- 2) Fix H-Sync width from V-Sync falling edge to first rising edge

#### 6.02 Vertical Timing Waveforms

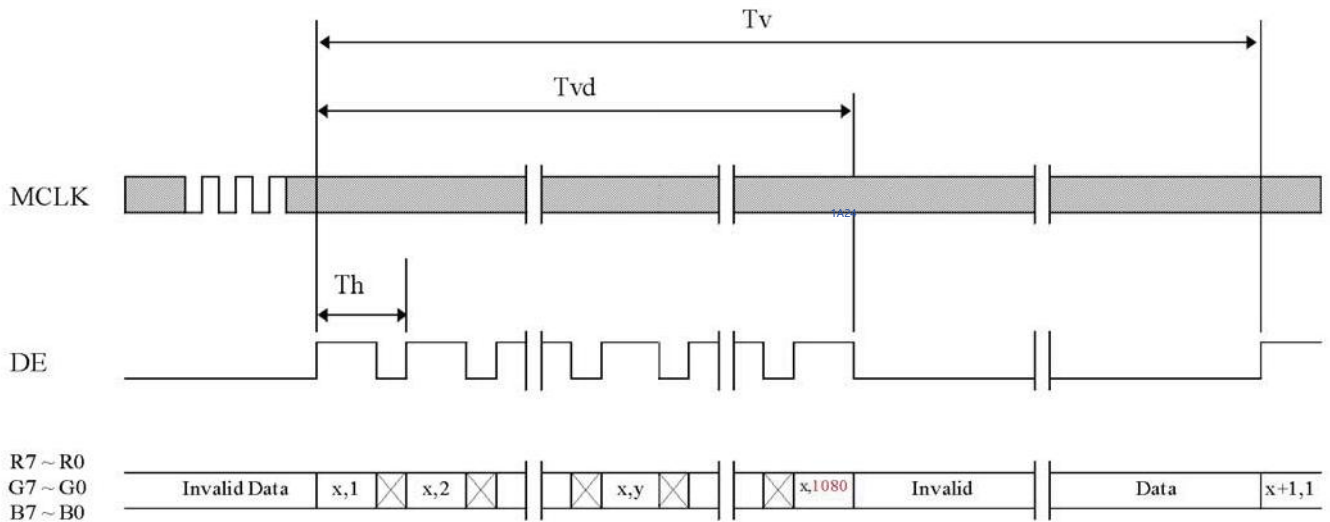

### 6.03 Horizontal Timing Waveforms

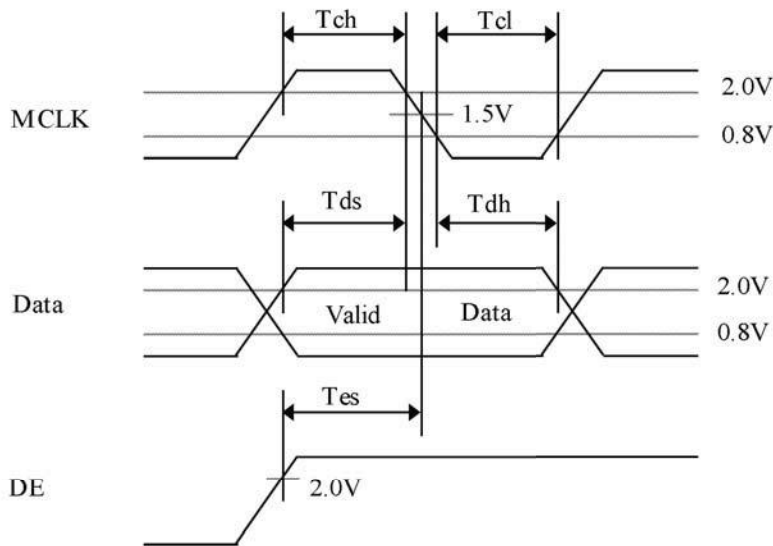
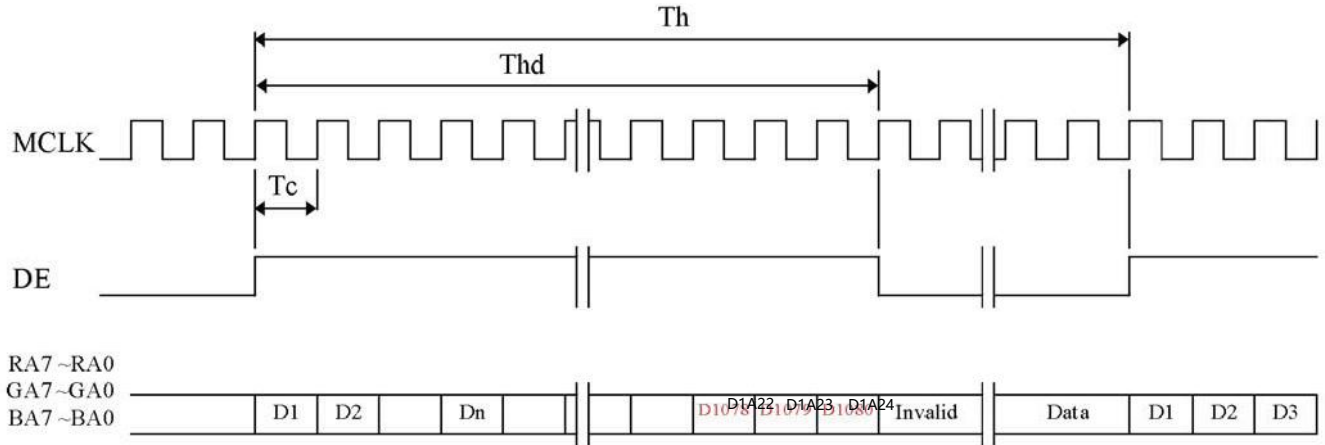

### 7.0 POWER SEQUENCE

To prevent a latch-up or DC operation of the LCD module, the power on/off sequence shall be as shown in below

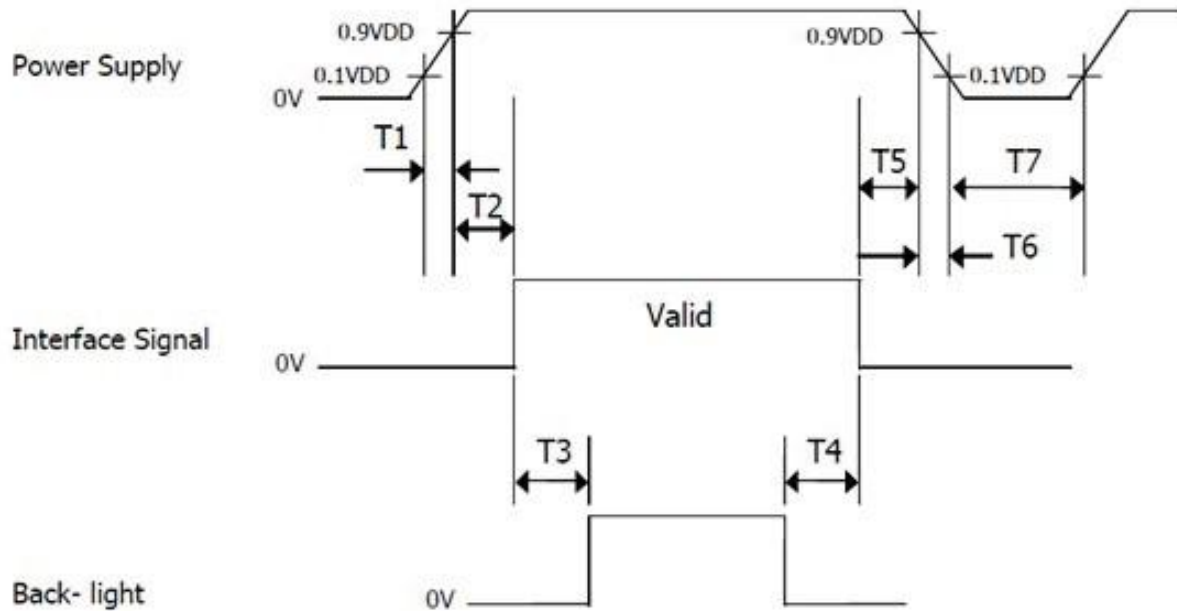

Parameter	Values			Units
	Min	Typ	Max	
T1	0.5	-	10	ms
T2	0	-	50	ms
T3	300	-	-	ms
T4	500	-	-	ms
T5	0	-	50	ms
T6	0	-	10	ms
T7	500	-	-	ms



### 8.0 OPTICAL SPECIFICATION

#### 8.0.1 Overview

The test of view angle range shall be measured in a dark room (ambient luminance  $\leq 1$ lux and temperature =  $25 \pm 2^\circ\text{C}$ ) with the equipment of Luminance meter system (Goniometer system and TOPCON CS2000/CA310) and test unit shall be located at an approximate distance 50cm from the LCD surface at a viewing angle of  $\theta$  and  $\Phi$  equal to  $0^\circ$ . We refer to  $\theta \Phi = 0$  ( $= \theta 3$ ) as the 3 o'clock direction (the "right"),  $\theta \Phi = 90$  ( $= \theta 12$ ) as the 12 o'clock direction ("upward"),  $\theta \Phi = 180$  ( $= \theta 9$ ) as the 9 o'clock direction ("left") and  $\theta \Phi = 270$  ( $= \theta 6$ ) as the 6 o'clock direction ("bottom"). While scanning  $\theta$  and/or  $\Phi$ , the center of the measuring spot on the Display surface shall stay fixed. The luminance, color and uniformity (etc) should be tested by CS2000/CA310. The backlight should be operating for 10 minutes prior to measurement. VDD shall be  $3.3 \pm 0.3\text{V}$  at  $25^\circ\text{C}$ . Optimum viewing angle direction is 6 'clock

<Table 10. Optical Specifications>

Parameter		Symbol	Condition	Min.	Typ.	Max.	Unit	Remark
Viewing Angle range	Horizontal	$\theta_3$	CR > 10	80	85	-	Deg.	Note 1
		$\theta_9$		80	85	-	Deg.	
	Vertical	$\theta_{12}$		80	85	-	Deg.	
		$\theta_6$		80	85	-	Deg.	
Luminance Contrast ratio		CR	$\theta = 0^\circ$	900	1200	-		Note 2
Luminance of White	Center	$Y_w$	$\theta = 0^\circ$	280	350	-	cd/m <sup>2</sup>	Note 3
White Luminance uniformity	9 Points	$\Delta Y_9$		80	85	-	%	Note 4
Color Gamut	NTSC	CIE1931	$\theta = 0^\circ$	65	70	-	%	Note 5
Reproduction of color	White	$W_x$	$\theta = 0^\circ$	Typ	0.286	Typ		
		$W_y$		-0.05	0.296			+0.05
Response Time		Tr+Td	Ta= $25^\circ\text{C}$ $\theta = 0^\circ$	-	30	35	ms	Note 6

Notes : 1. Viewing angle is the angle at which the contrast ratio is greater than 10. The viewing angles are determined for the horizontal or 3, 9 o'clock direction and the vertical or 6, 12 o'clock direction with respect to the optical axis which is normal to the LCD surface (see FIGURE 1).

2. Contrast measurements shall be made at viewing angle of  $\Theta = 0$  and at the center of the LCD surface. Luminance shall be measured with all pixels in the view field set first to white, then to the dark (black) state . (see FIGURE 1) Luminance Contrast Ratio (CR) is defined mathematically.

$$CR = \frac{\text{Luminance when displaying a white raster}}{\text{Luminance when displaying a black raster}}$$

3. Luminance of white is defined as luminance values of center of the LCD surface. Luminance shall be measured with all pixels in the view field set first to white. This measurement shall be taken at the locations shown in FIGURE 2 for a total of the measurements per display. The luminance is measured by CS2000/CA310 when the LED current is set at 60mA.
4. The White luminance uniformity on LCD surface is then expressed as :  $\Delta Y = \text{Minimum Luminance of 9 Points or 5 points} / \text{Maximum Luminance of 9 Points or 5 points}$ (See FIGURE 2).
5. The color chromaticity coordinates specified in Table 5. shall be calculated from the spectral data measured with all pixels first in red, green, blue and white. Measurements shall be made at the center of the panel.
6. The electro-optical response time measurements shall be made as FIGURE 3 by switching the "data" input signal ON and OFF. The times needed for the luminance to change from 10% to 90% is  $T_r$ , and 90% to 10% is  $T_d$ .

### 8.0.2 Optical measurements

**Figure 1. Measurement Set Up**

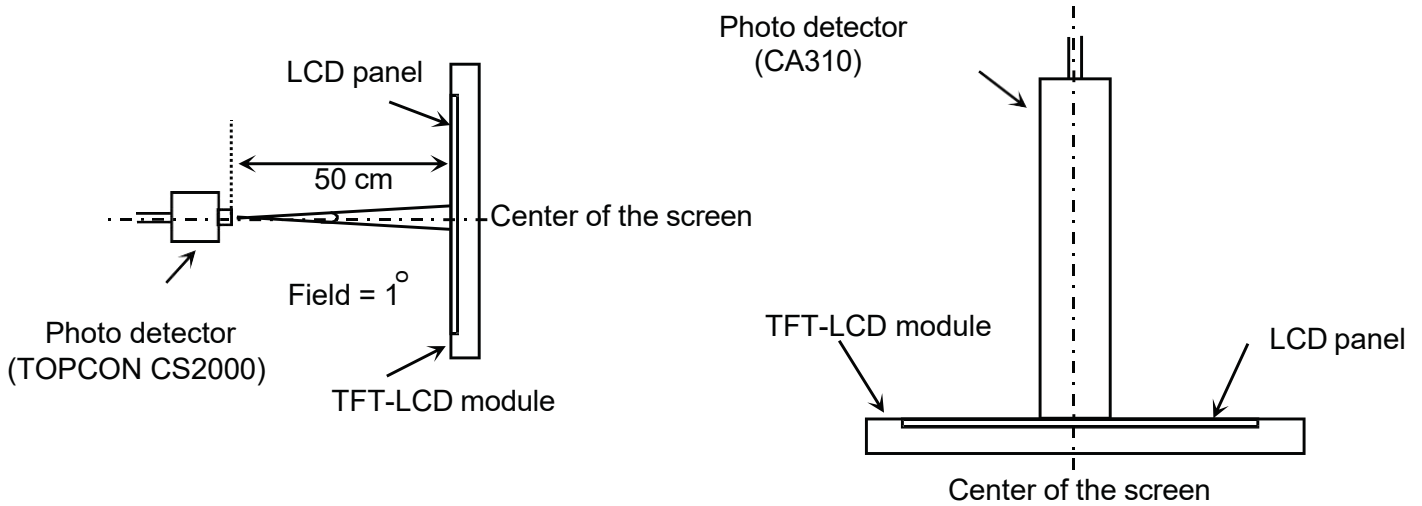

View angel range, uniformity, etc. measurement setup

Flicker, measurement setup

**Figure 2. White Luminance and Uniformity Measurement Locations (9 points)**

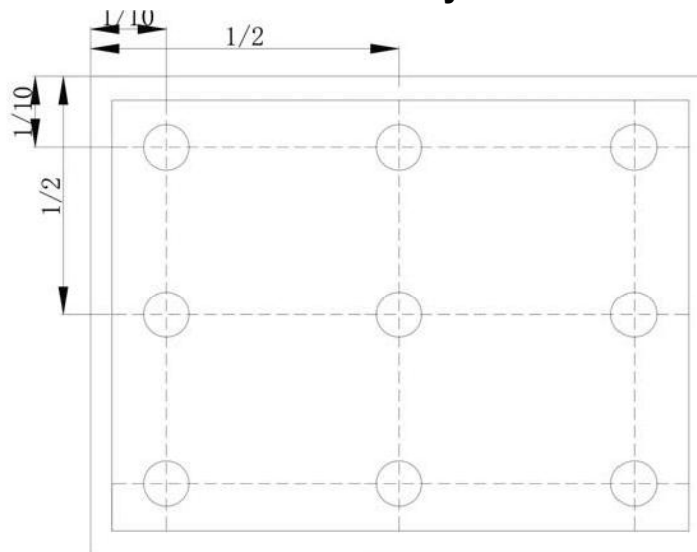

Luminance of white is defined as luminance values of center of the LCD surface. Luminance shall be measured with all pixels in the view field set first to white. This measurement shall be taken at the locations shown in FIGURE 2 for a total of the measurements per display.

The White luminance uniformity on LCD surface is then expressed as :  $\Delta Y9 = \text{Minimum Luminance of 9 points} / \text{Maximum Luminance of 9points}$  (see FIGURE 2).

**Figure 3. Response Time Testing**

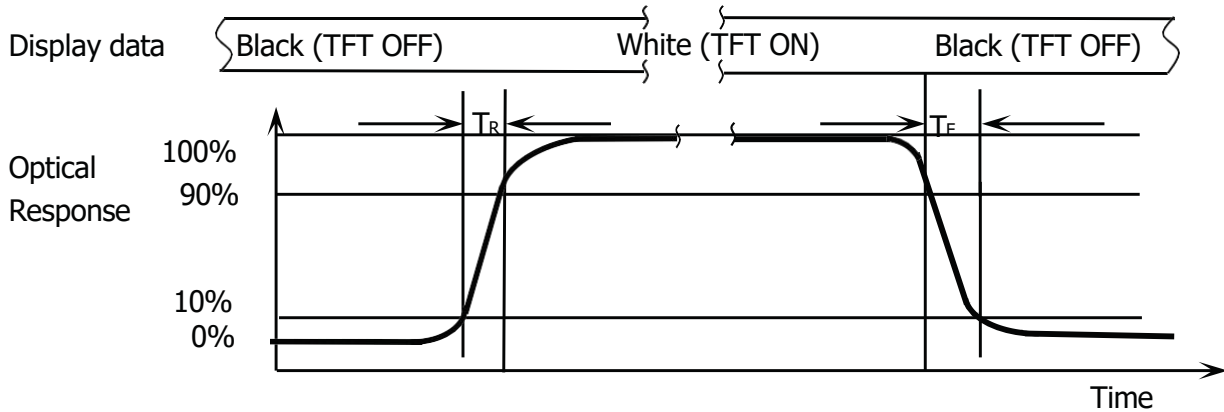

The electro-optical response time measurements shall be made as shown in FIGURE 3 by switching the “data” input signal ON and OFF. The times needed for the luminance to change from 10% to 90% is  $T_r$  and 90% to 10% is  $T_d$ .

## 9.0 MECHANICAL OUTLINE DIMENSION

Figure 1. TFT-LCD Module Outline Dimension (Front View)

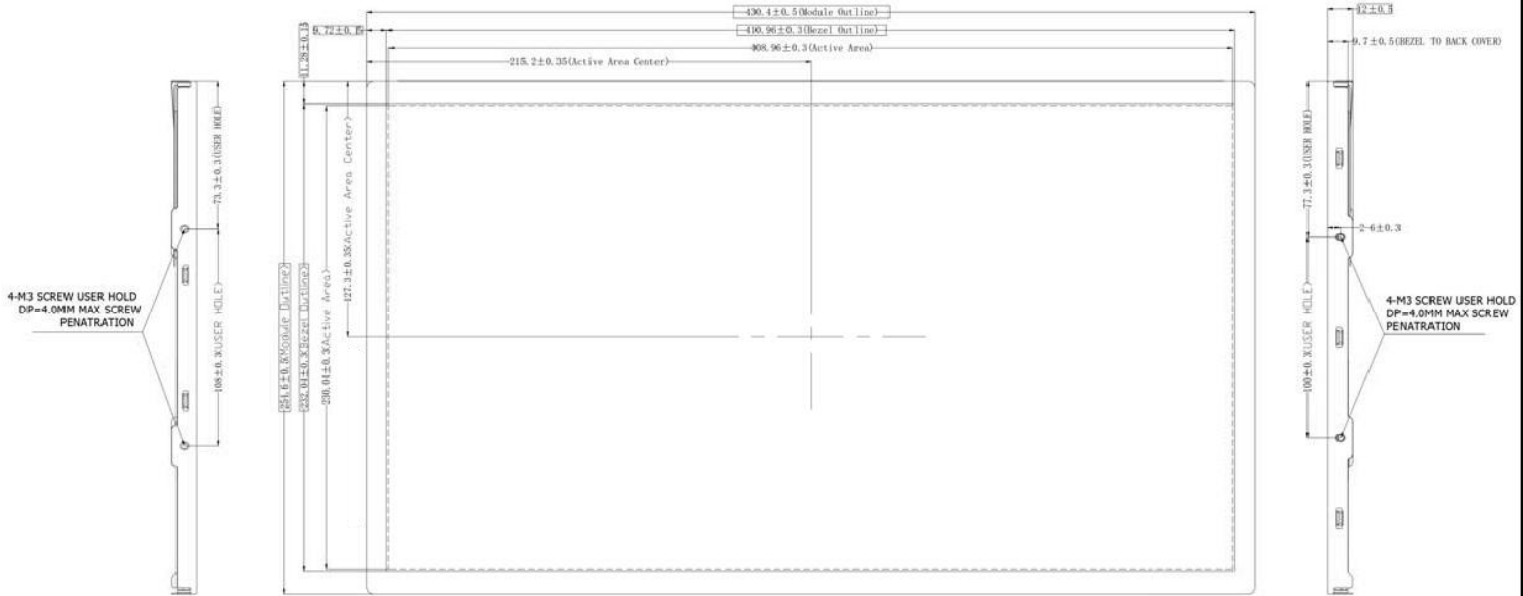

### NOTE:

1. BLACK LIGHT: LED WHITE;  
LCM BRIGHTNESS (CENTER POINT):  $280 \text{cd/m}^2$  (Min),  $350 \text{cd/m}^2$  (Typ)
2. GENERAL TOLERANCE:  $\pm 0.5 \text{mm}$ ;
3. CRITICAL CENTRAL POINT ,  
REFERENCED DIMENSION ( );
4. CONFORMITY WITH RoHS AND HALOGEN FREE;
5. OPERATING TEMPERATURE:  $-20^\circ\text{C}$  (Min.),  $70^\circ\text{C}$  (Max.);
6. STORAGE TEMPERATURE:  $-30^\circ\text{C}$  (Min.),  $80^\circ\text{C}$  (Max.);
7. LCM HOMOGENEITY: 80% (min), 85% (typ), L255@9 Point;
8. CN1: IS100-L300-C23 CN2&CN3: CI4216S;

SPEC. NUMBER

**S801-5126**

SPEC TITLE

**XX 品 FG-code** Product Specification

PAGE

21 OF 31

Figure 2. TFT-LCD Module Outline Dimensions (Rear view)

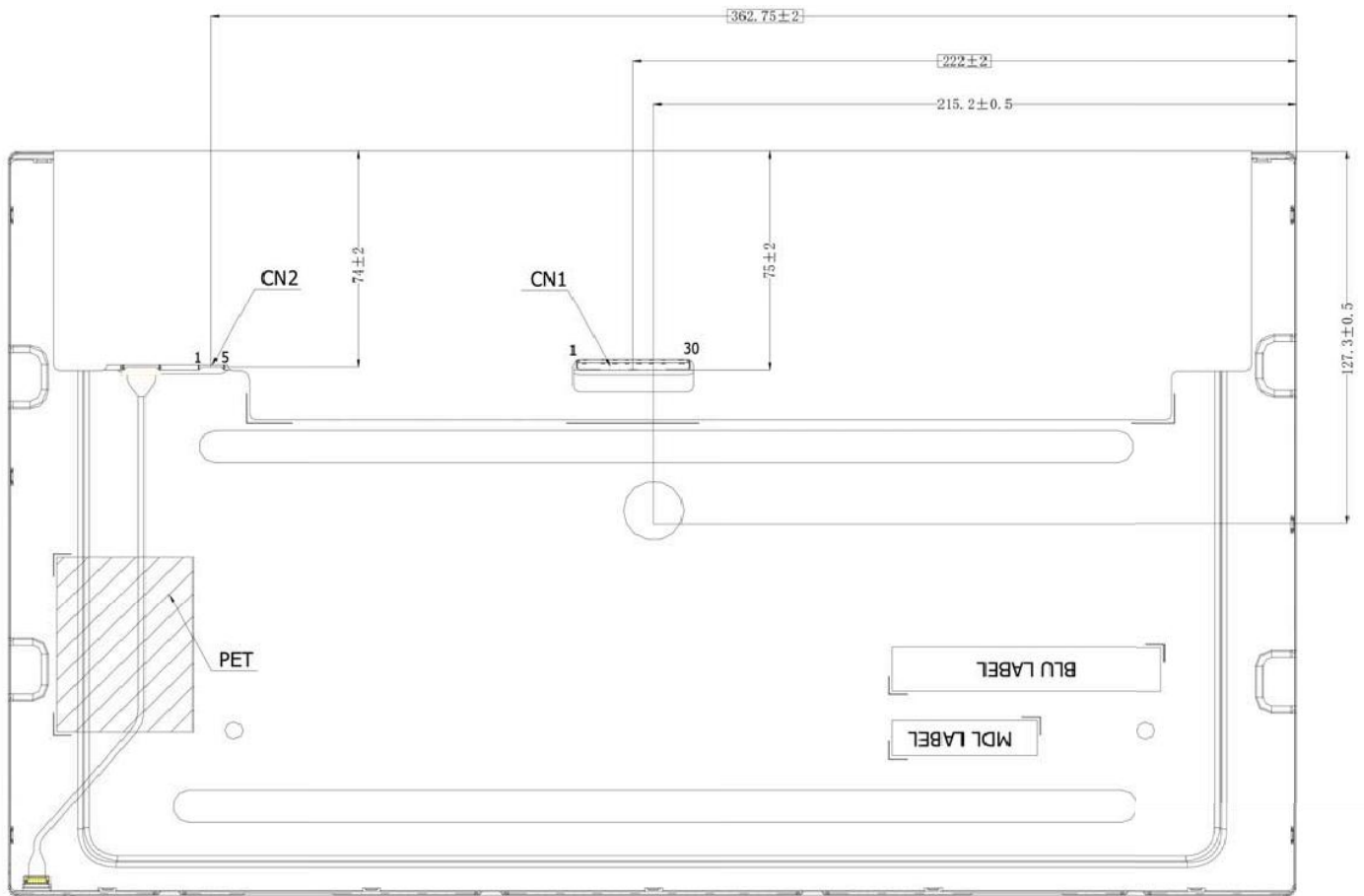

**10.0 RELIABILITY TEST (34β6789,;4β < =J67,3J@AB8B)**

The Reliability test items and its conditions are shown in below.

<Table 11. Reliability test>

No	Test Items	Conditions	Remark	
1	High temperature storage test	Ta = 80°C, 240 hrs	The test result shall be evaluated after the sample has been left at room temperature and humidity for 2 hours. These defects can't be accepted: 1. Air bubble 2. Seal leak 3. Non-display 4. Missing segments 5. Glass crack	
2	Low temperature storage test	Ta = -30 °C, 240 hrs		
3	High temperature operation test	Ta = 80°C, 240 hrs		
4	Low temperature operation test	Ta = -30 °C, 240 hrs		
5	High temperature & high humidity	Ta = 60 °C, 90%RH, 240 hrs		
6	Thermal shock(Non-operation)	Ta = -40 °C ↔ 80°C (0.5 hr), 1hour/Cycle,100 cycle		
7	Shock test (Non-operation)	5AG,11ms,sine Wave,1time for each axis,X,Y,Z directions		
8	ESD test(operation)	C=15ApF, R=33AΩ, Air: ±15KV, Contact: ±8KV,1AApoint		Air: PANEL AA around Contact: BEZEL Class B
9	Vibration Test(Non-operation)	1.5G,1A~2AAHz,3Amin/AXI S X,Y,Z directions Wave:sine		
10	Package Drop Test	Height: 60cm, 1corner, 3edges, 6surfaces		

Note = (1)After the reliability test, the product only guarantee function normally without any fatal defect (non-display, line defect, abnormal display etc ). All the cosmetic specification is judged before the reliability test.

(2)The above reliability tests are based on the industrial monitoring conditions that the customer uses for indoor environment and operates for 7 \* 16h, and refers to the direct requirements released by the customer ; the change of terminal application environment shall be reviewed by BOE in advance to confirm the risk.

## • 11.0 Precautions

Please pay attention to the followings when you use this TFT LCD Panel.

### • 11.1 Mounting Precautions

- (1) Use fingerstalls with soft gloves in order to keep display clean during the incoming inspection and assembly process.
- (2) You must mount a module using specified mounting holes (Details refer to the drawings).
- (3) Please make sure to avoid external forces applied to the Source PCB or FPC and D-IC during the process of handling or assembling. If not, It causes panel damage or malfunction.
- (4) Note that polarizers are very fragile and could be easily damaged. Do not touch, push or rub the exposed polarizers with glass, tweezers or anything harder than HB pencil lead. And please do not rub with dust clothes with chemical treatment.
- (5) Do not pull or fold the source D-IC which connect the source PCB or FPC and the panel.
- Do not pull or fold the LED wire.
- (6) After removing the protective film, when the surface becomes dusty, please wipe gently with absorbent cotton or other soft materials like chamois soaks with alcohol or purified water.
- Do not strong polar solvent because they cause chemical damage to the polarizer.
- (7) Wipe off saliva or water drops as soon as possible. Their long time contact with polarizer causes deformations and color fading.
- (8) Protection film for polarizer on the module shall be slowly peeled off just before use so that the electrostatic charge can be minimized.
- (9) Since the LCD is made of glass, do not apply strong mechanical impact or static load onto it. Handling with care since shock, vibration, and careless handling may seriously affect the product. If it falls from a high place or receives a strong shock, the glass may be broken.
- (10) Do not disassemble the module.
- (11) To determine the optimum mounting angle, refer to the viewing angle range in the specification for each model.
- (12) If the customer's set presses the main parts of the LCD, the LCD may show the abnormal display. But this phenomenon does not mean the malfunction of the LCD and should be pressed by the way of mutual agreement.
- (13) Do not drop water or any chemicals onto the LCD's surface.
- (14) The ITO pad area needs special careful caution because it could be easily corroded. Do not contact the ITO pad area with HCFC, Soldering flux, Chlorine, Sulfur, saliva or fingerprint. To prevent the ITO corrosion, customers are recommended that the ITO area would be covered by UV or silicon.

Q:R (4)(6)(7)(8) STUPoIVWXYZ[]OC/MDL] ^)` ,abQ/SinglecdepolfiLCD surface,hijkf8X

②f(14)XZ[]Q/Single] ^)` (MDL/OCipkqX)



## 11.2 Operating Precautions

- (1) Be careful for condensation at sudden temperature change. Condensation makes damage to polarizer or electrical contacted parts. And after fading condensation, smear or spot will occur.
- (2) Module has high frequency circuits. Sufficient suppression to the electromagnetic interference shall be done by system manufacturers. Grounding and shielding methods may be important to minimized the interference.
- (3) The electrochemical reaction caused by DC voltage will lead to LCD degradation, so DC drive should be avoided.
- (4) The LCD modules use C-MOS LSI drivers, so customers are recommended that any unused input terminal would be connected to Vdd or Vss, do not input any signals before power is turn on, and ground you body, work/assembly area, assembly equipments to protect against static electricity.
- (5) Do not exceed the absolute maximum rating value. (supply voltage variation, input voltage variation, variation in part contents and environmental temperature, and so on) Otherwise the Module may be damaged.
- (6) Design the length of cable to connect between the connector for back-light and the converter as short as possible and the shorter cable shall be connected directly.  
The longer cable between that of back-light and that of converter may cause the luminance of LED to lower and need a higher startup voltage(Vs).
- (7) Connectors are precise devices for connecting PCB and transmitting electrical signals. Operators should insert and unplug MDL in parallel when assembling MDL.
- (8) Do not connect or disconnect the cable to/ from the module at the "Power On" condition.
- (9) When the module is operating, do not lose CLK, ENAB signals. If any one these signals is lost, the LCD panel would be damaged.
- (10) Obey the supply voltage sequence. If wrong sequence is applied, the module would be damaged.
- (11) Do not re-adjust variable resistor or switch etc.
- (12) Long Side LED Bar design is recommended when using E-LED type Back Light (GOA Panel Q /Single/OCΩ )

Q:

R(1)STUPoIVWXYZ[]OC/MDL]^`  
 ②(6)(7)STUconnectorVWZ[]OC/MDL]^`

## 11.3 Electrostatic Discharge Control

- (1) Since a module is composed of electronic circuits, it is not strong to electrostatic discharge. Make certain that treatment persons are connected to ground through wrist band etc. And don't touch interface pin directly. Keep products as far away from static electricity as possible.
- (2) Avoid the use work clothing made of synthetic fibers. We recommend cotton clothing or other conductivity-treated fibers.
- (3) In order to prevent potential problems, Flicker should be adjusted by Optimizing the Vcom value in customer LCM line through the I2C interface.fl (IFQ/Single/OCΩ

### 11.4 Precautions for Strong Light Exposure

It is not allowed to store or Operate directly in strong light or in high temperature and humidity for a long time; Strong light exposure causes degradation of polarizer and color filter.

### 11.5 Storage Precautions

When storing modules as spares for a long time, the following precautions are necessary.

- (1) The polarizer surface should not come in contact with any other object.  
It is recommended that they be stored in the container in which they were shipped.  
Temperature : 5 ~ 40 T
- (2) Humidity : 35 ~ 75 %RH
- (3) Period : 6 months
- (4) Control of ventilation and temperature is necessary.
- (5) Please make sure to protect the product from strong light exposure, water or moisture.  
Be careful for condensation.
- (6) Store in a polyethylene bag with sealed so as not to enter fresh air outside in it.
- (7) Do not store the LCD near organic solvents or corrosive gasses.
- (8) Please keep the Modules/OC/FOG at a circumstance shown below Fig.

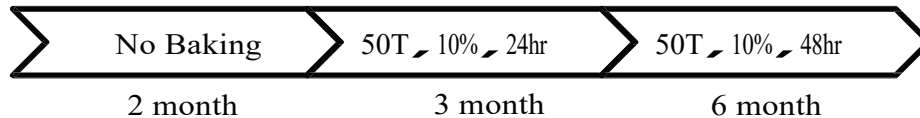

### 11.6 Precautions for Protection Film (DEFESH, IQ/Single Production)

- (1) Remove the protective film slowly, keeping the removing direction approximate 30-degree not vertical from panel surface, If possible, under ESD control device like ion blower, and the humidity of working room should be kept over 50%RH to reduce the risk of static charge.
- (2) In handling the LCD, wear non-charged material gloves. And the conducting wrist to the earth and the conducting shoes to the earth are necessary.

### 11.7 Appropriate Condition for Display

- (1) Normal operating condition
  - Temperature: 0 ~ 40T
  - Operating Ambient Humidity : 10 ~ 90 %
  - Display pattern: dynamic pattern (Real display)
  - Suitable operating time: under XX hours a day.( Please contract BOE in advance for 7\*24hrs or more than suggested Operating time, ,X./I01 23456 品 )
  - Long-term lighting products recommended regular shutdown

•(2) Special operating condition  
If the product will be used in extreme conditions such as high temperature, humidity, display patterns or 7\*24hrs operation time etc., It is strongly recommended to contact BOE for Application engineering advice. Otherwise, its reliability and function may not be guaranteed.

- (3) Black image or moving image is strongly recommended as a screen save.

- (4) Lifetime in this spec. is guaranteed only when commercial display is used according to operating usages.
- (5) Please contact BOE in advance when you want to switch between portrait and landscape screen ( 9: - ;fl )
- (6) Please contact BOE in advance for outdoor operation.
- (7) Please contact BOE in advance when you display the same pattern for a long time.
- (8) If the Module keeps displaying the same pattern for a long period of time, the image may be "sticked" to the screen. To avoid image sticking, it is recommended to use a screen saver.
- (9) Do not exceed the absolute maximum rating value. (supply voltage variation, input voltage variation, variation in part contents and environmental temperature, and so on) Otherwise the Module may be damaged.
- (10) Dew drop atmosphere should be avoided.
- (11) The storage room should be equipped with a good ventilation facility and avoid to expose to corrosive gas , which has a temperature controlling system.
- (12) When expose to drastic fluctuation of temperature (hot to cold or cold to hot) ,the LCD may be affected; Specifically, drastic temperature fluctuation from cold to hot ,produces dew on the LCD's surface which may affect the operation of the polarizer and the LCD.
- (13) Response time will be extremely delayed at lower temperature than the operating temperature range and on the other hand at higher temperature LCD may turn black at temperature above its operational range. However those phenomena do not mean malfunction or out of order with the LCD. The LCD will revert to normal operation once the temperature returns to the recommended temperature range for normal operation

### 11.8 Others

#### A. LC Leak

- If the liquid crystal material leaks from the panel, it is recommended to wash the LC with acetone or ethanol and then burn it.
- In case of contact with hands, skin or clothes, it has to be washed away thoroughly with soap.
- If LC in mouth, mouth need to be washed, drink plenty of water to induce vomiting and follow medical advice.
- If LC touch eyes, eyes need to be washed with running water at least 15 minutes.

#### B. Rework

- When returning the module for repair or etc., Please pack the module not to be broken. We recommend to use the original shipping packages.

### 12.0 LABEL

#### (1) Product label

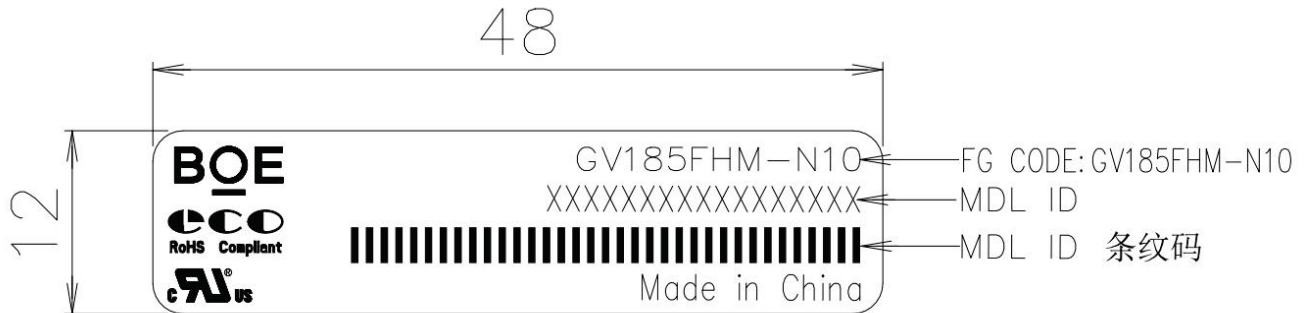

#### MDL ID 编码规则

序列号	1	2	3	4	5	6	7	8	9	10	11	12	13	14	15	16	17
代码	X	X	P	3	5	2	7	X	X	X	X	0	0	1	E	E	J
描述	生管指定		等级 S,A,P,Q 等	工厂 B3	年	月	FG Code后四位				流水码 36进制(无I和O)						

年: 2015—15, 2016—16 ..... 2020--20, 2021--21.....  
 月: 1~12月→ 1~9, X, Y, Z

(2) Box label

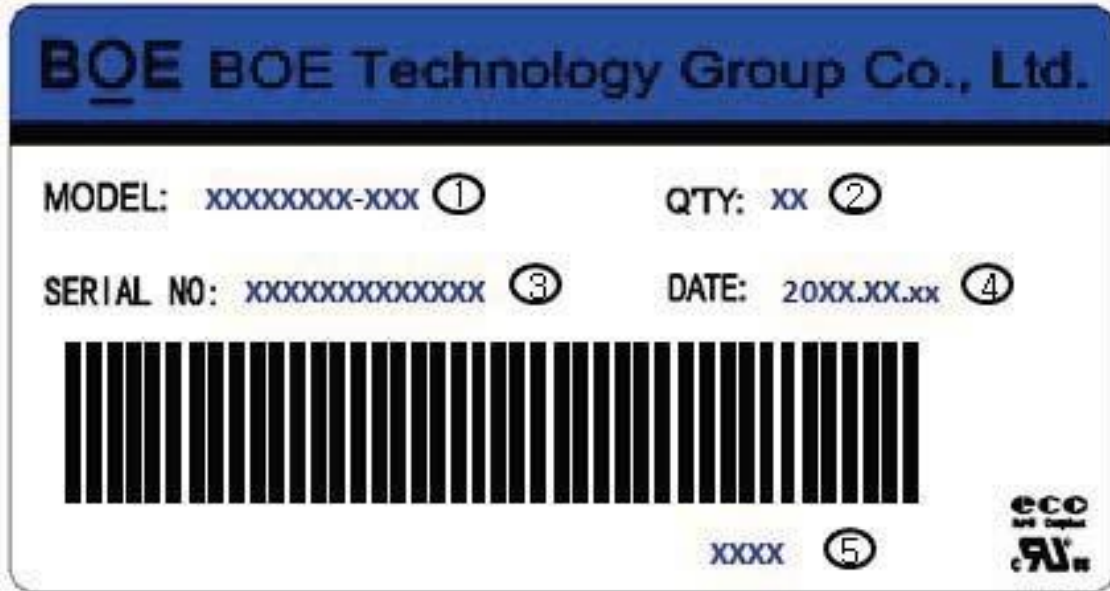





Serial number marked part needs to print, show as follows:

1. FG-CODE(Before 12 bit) : GV185FHM-N10
2. Product quantity
3. Box ID
4. Date
5. FG-Code After four---3M30

Total Size:110×55mm

### 13.0 PACKING INFORMATION

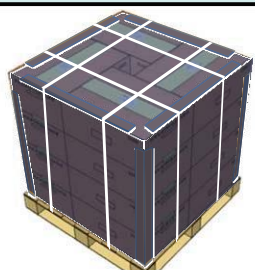
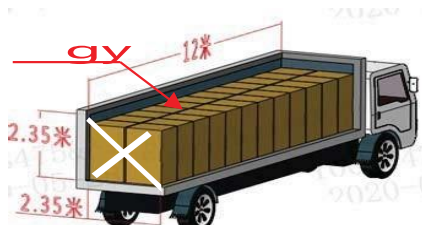
<p>e EPE Bottom s)uvw</p>	<p>eLCMx)PEyz,{ )}~ , \$e9pcs PEy LCM(PCB y) s)Bottomb™ w</p>
 <p style="text-align: right;">Step 1</p>	 <p style="text-align: right;">Step 2</p>
<p>e EPE Cover Bottom , \$euv[ x :9 LCM/Box, 9 PE Bag/Box</p>	<p>e16ea x uvsU , :144 LCM/Pallet</p>
 <p style="text-align: right;">Step 3</p>	 <p style="text-align: right;">Step 4</p>
<p>s\$8eau , [ (≥3 )\$ [ " "</p>	<p>x : s, s x _12m:3168 pcs(22 )</p>
 <p style="text-align: right;">Step 5</p>	 <p style="text-align: right;">Step 6</p>